

TYPE	OUTPUT		POLE	TIME RATING	VOLTAGE V	Hz	SYN. SPEED R. P. M
	HP.	KW.					
AEEAGD	250	187	6	CONT.	460	60	1200

TOTALLY ENCLOSED FAN-COOLED TYPE. SQUIRREL-CAGE ROTOR

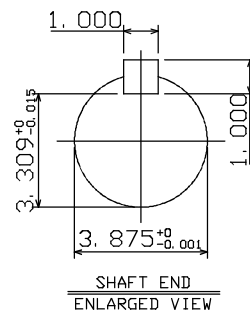
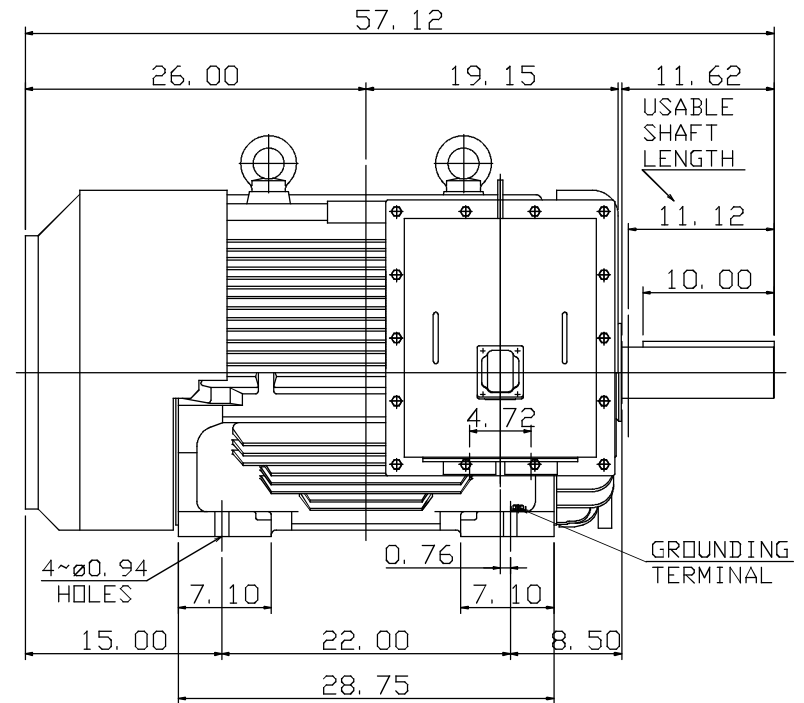
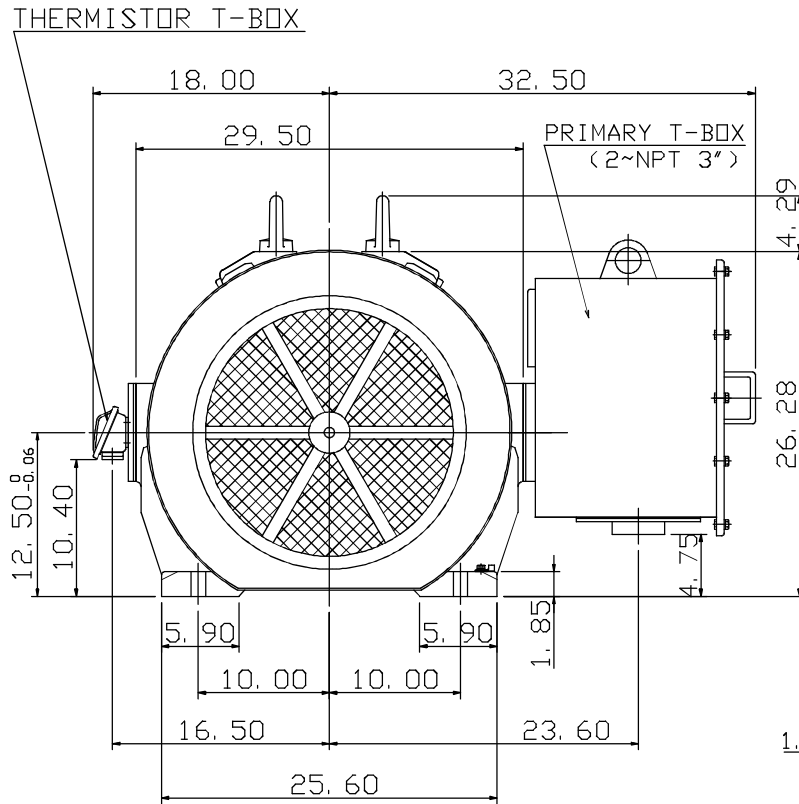

NOTE:

- DIMENSIONS IN INCHES
- FRAME NO. 5007C
- F CLASS INSULATION, S. F. 1.0 (50Hz)  
F CLASS INSULATION, S. F. 1.15 (60Hz)
- FOR BELT SERVICE
- BEARING SIZE: DRIVE END: NU324C3  
NON-DRIVE END: 6320C3
- ENCLOSURE: IP55
- WITH THERMISTOR: PTC 140°C 3PCS
- SHAFT MATERIAL: SCM440 Q&T (AISI 4140 EQUIV)
- MOTOR APPROX. WEIGHT: 3700 LBS

4A040Y699

DWN.	C. RAM	DEC 02 2015
DWN.	H. CHANG	MAR 03 2015
CHKD.	H. HUANG	MAR 03 2015
APPD.	C. LIU	MAR 03 2015

CATALOG NO.

CD2506R

TEC Westinghouse

OUTLINE DIMENSIONS  
3-PHASE INDUCTION MOTOR

DWG NO. REV: 00

4A040Y687