

### Dimensional Drawing

Catalogue	Model	HP	Pole	kW	Rating	Voltage	Hz	RPM
HT40085R	AEEAGD	400	8	298	Continuous	575 V	60	900

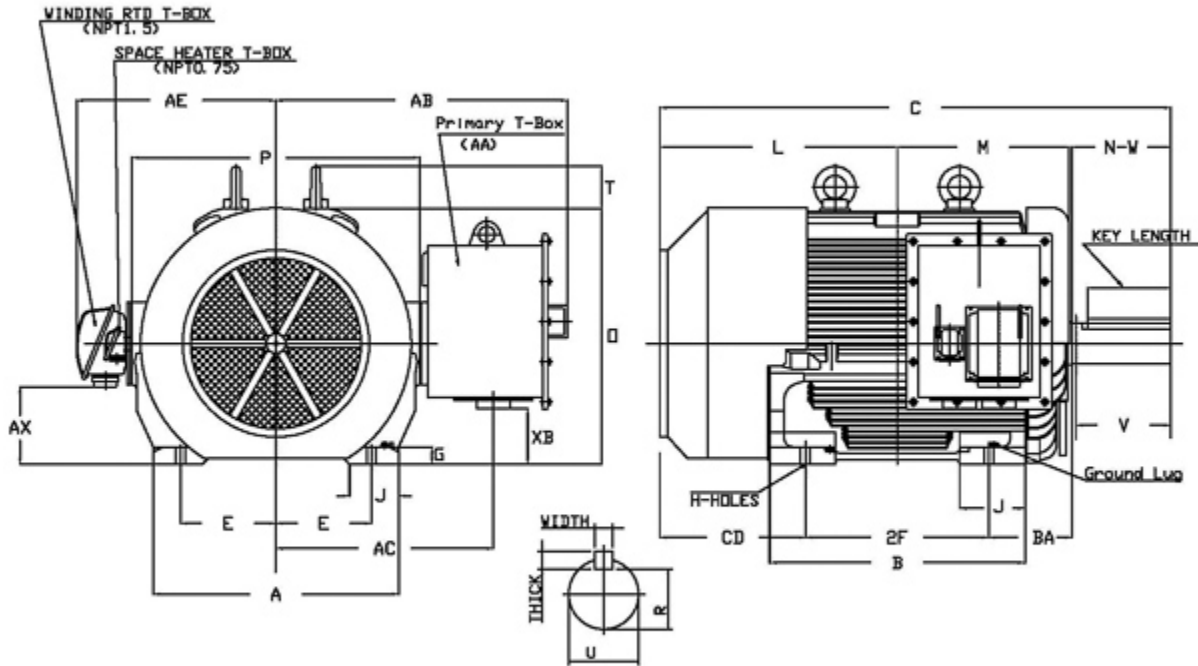

Frame Size	Mounting					A	B	C	CD	D	
	E	2F	2F2	H	BA						
5808C	11.5	28		1.13	10	29.55	36.6	67.38	17.5	14.5	
G	J	K	L	M	O	P	T	Key			Keyseat
								Width	Thick	Length	R
2.1	5.9	9.65	31.5	23.4	30.7	35.4	5.05	1.25	1.25	10	4.169
Terminal Housing			Aux Box			C/D Flange					
AA	AB	AC	XB	AE	AX	BB	AH	AK	BD	AJ	BF
2x 3 NPT	29.35	26.14	6.75	24	9.3						
Shaft Extension			Bearings		Approx. Weight Lbs	SPL dBA/3ft	Ins. Class	S.F.	Drive Method	Dimensions	
N-W	U	V	DE	NDE							
11.88	4.875	11.38	NU326	6322	5550	85	F	1.15	Belt Drive	Inches	

### Technical Data Sheet

Motor Type: AEEAGD

Catalogue No: HT40085R

#### Nameplate Information

HP	Pole	RPM	Frame	Voltage	Hz	Phase
400	8	890	5808C	575	60	3
Enclosure	Ins. Class	Service Factor	Time Rating	NEMA Design	Rated Amb.	Rated Altitude
TEFC	F	1.15	Continuous	C	-40 to 40 °C	<3300 ft

#### Typical Performance

Efficiency (%)				Power Factor (%)		
Full Load		3/4 Load	1/2 Load	Full Load	3/4 Load	1/2 Load
Nom.	Min.					
95.0	94.1	93.6	92.0	81.0	77.0	68.5
Torque				Current (A)		
Full Load (lb-ft)	Locked Rotor (% FLT)	Pull Up (% FLT)	Break Down (% FLT)	No Load	Full Load	Locked Rotor
2360.00	200	160	250	146.4	389.4	2320
NEMA KVA Code	Inertia (WR <sup>2</sup> )			Safe Stall Time (s)		Noise Level Sound Press. dB(A)
	Rotor (lb-ft <sup>2</sup> )	NEMA Load (lb-ft <sup>2</sup> )	Max. Allowable (lb-ft <sup>2</sup> )	Cold	Hot	
G	497.000	8500	21250	20	15	85

#### VFD Duty Information

Speed Range			VFD		S.F.
Constant Torque	Variable Torque	Constant Power	Carrier	Type	
20-60Hz	3-60Hz	60-120Hz	≤ 3 kHz	VPWM or CPWM	1.0 Only

#### Additional Information

Bearings		Approx. Weight
DE	NDE	lbs
NU326	6322	5550

#### Hazardous Locations Information

Temp Code (Sinewave / VFD)	/
----------------------------	---