

Dimensões em polegada
Dimensions in inches

THIS IS AN UPDATED REVISION, THE
PREVIOUS ONE MUST BE DISREGARDED.

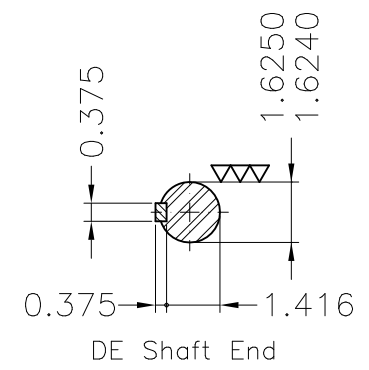
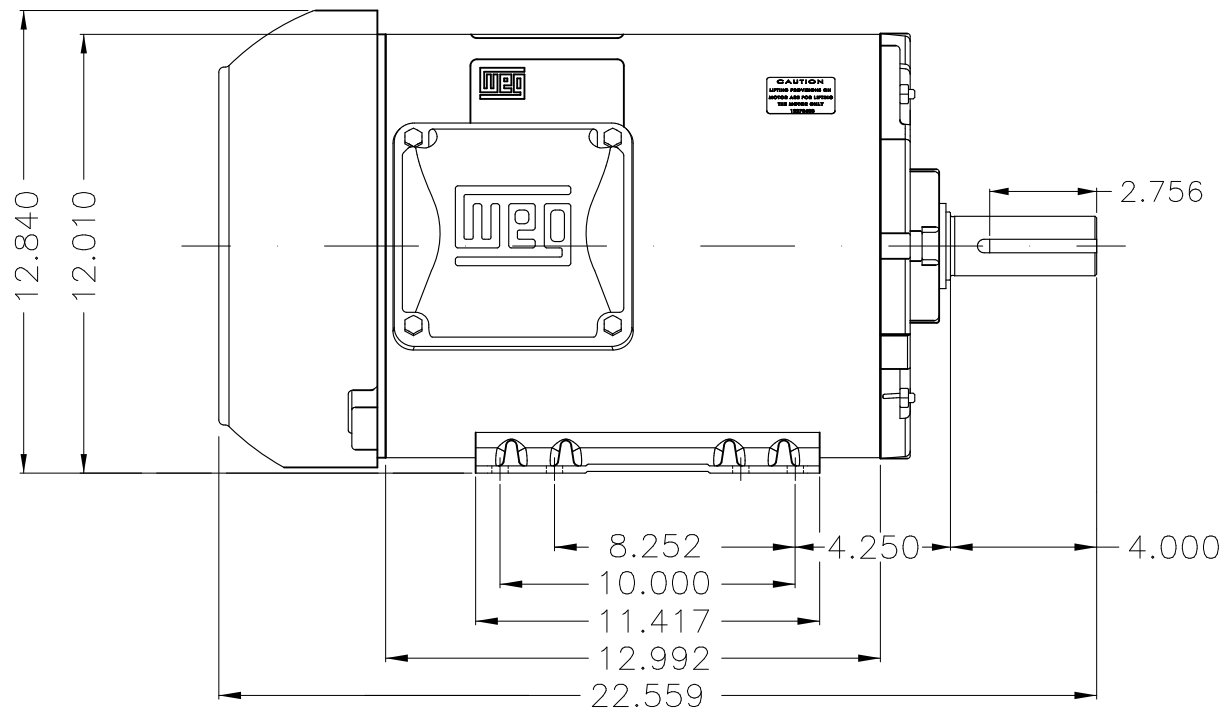
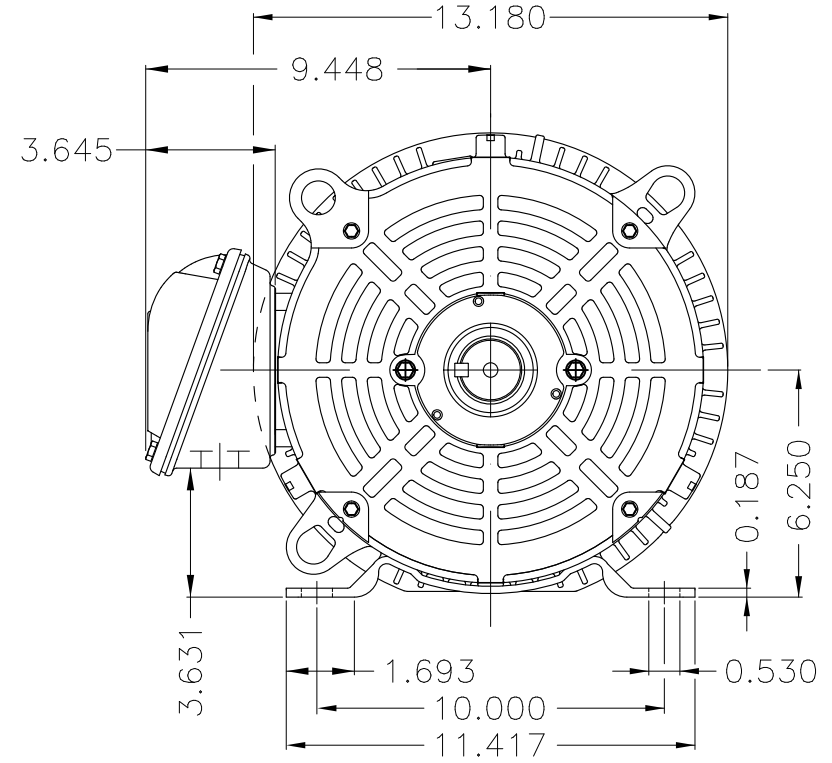
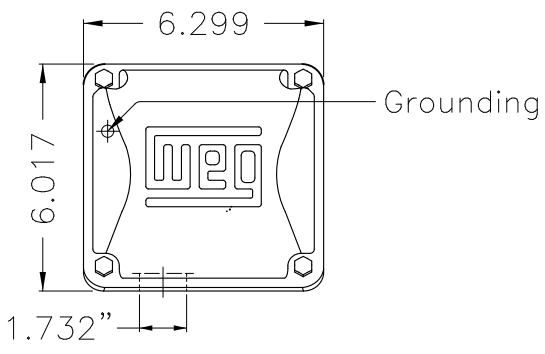
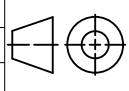

- Brush holder Kit AEGIS internal DE
- Bearing cap
- Color Munsell N 1 matte black
- Painting plan 207N
- Mounting F-1/B3R(D)

ECM	LOC	SUMMARY OF MODIFICATIONS	EXECUTED	CHECKED	RELEASED	DATE	VER
EXECUTED	USERADMIN	 THREE P. MOTOR TEFC ROLLED STEEL NEMA P. FRAME 254/6T IP55 TEFC WEG code: 12793363					
CHECKED							
RELEASED							
REL DT	24.07.2017	WMO Jaragua do Sul	Product Engineering	SHEET	1 / 1		

15 HP 04 Poles 60Hz

A

