

Dimensões em polegada
Dimensions in inches

THIS IS AN UPDATED REVISION, THE
PREVIOUS ONE MUST BE DISREGARDED.

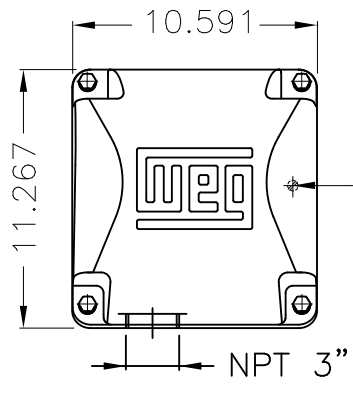

Grounding for leads 25-50 mm² / 3-1 AWG

Main terminal box

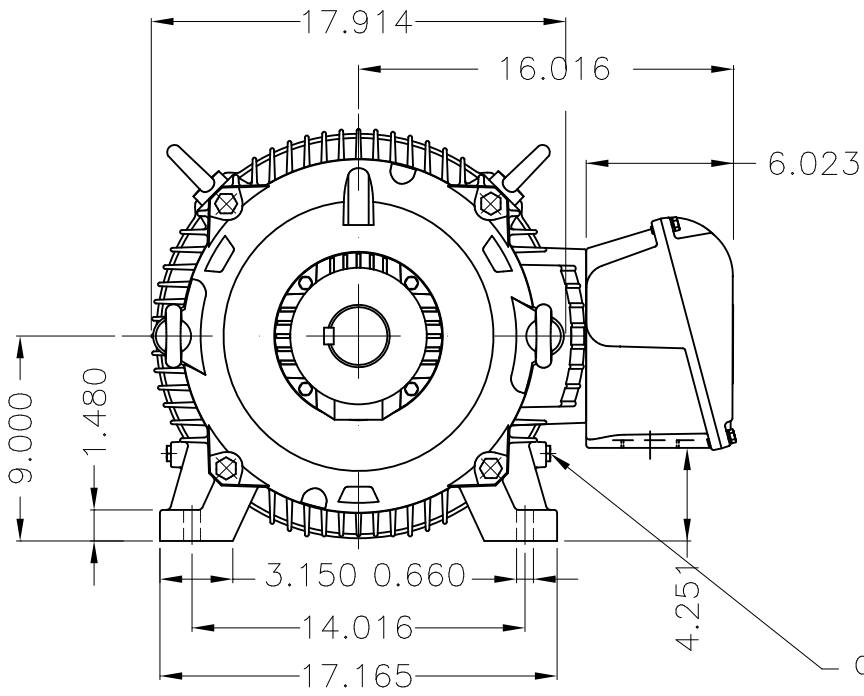

Grounding for leads 25-185 mm² / 3AWG-350MCM

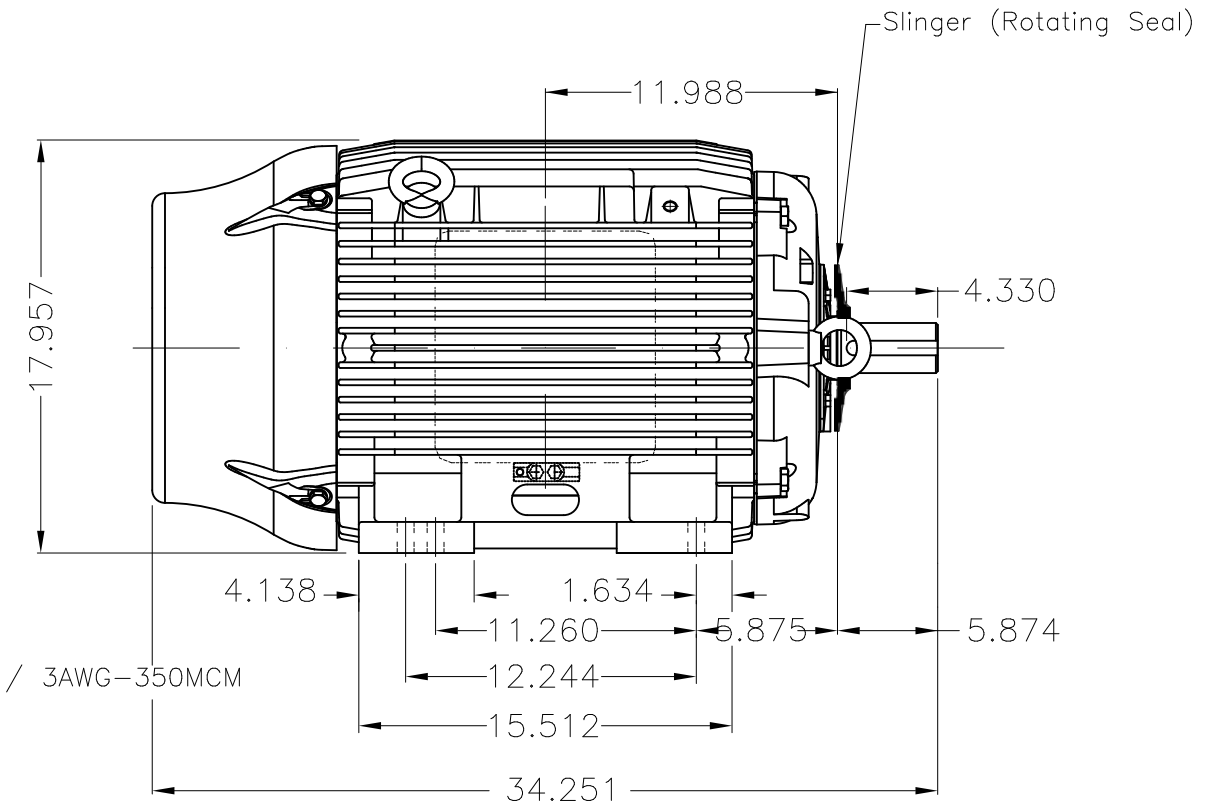

Slinger (Rotating Seal)

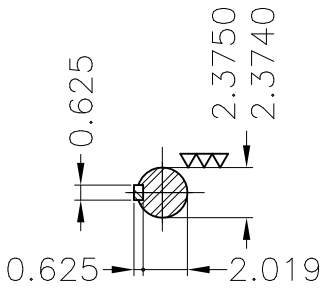

DE Shaft End

Color RAL 5009
Painting plan 202E
Mounting B3L(E)

ECM	LOC	SUMMARY OF MODIFICATIONS	EXECUTED	CHECKED	RELEASED	DATE	VER
EXECUTED	USERADMIN	THREE PH W22 MOTOR COOLING TOWER HIGH EF					
CHECKED		FRAME 364/5T IP55 TEFC					
RELEASED		WEG code: 12174886					
REL DT	24.07.2017	WMO Jaragua do Sul	Product Engineering	SHEET	1 / 1		

10/40 HP 08/04 Poles 60Hz

A

