

Dimensões em polegada
Dimensions in inches

THIS IS AN UPDATED REVISION, THE
PREVIOUS ONE MUST BE DISREGARDED.

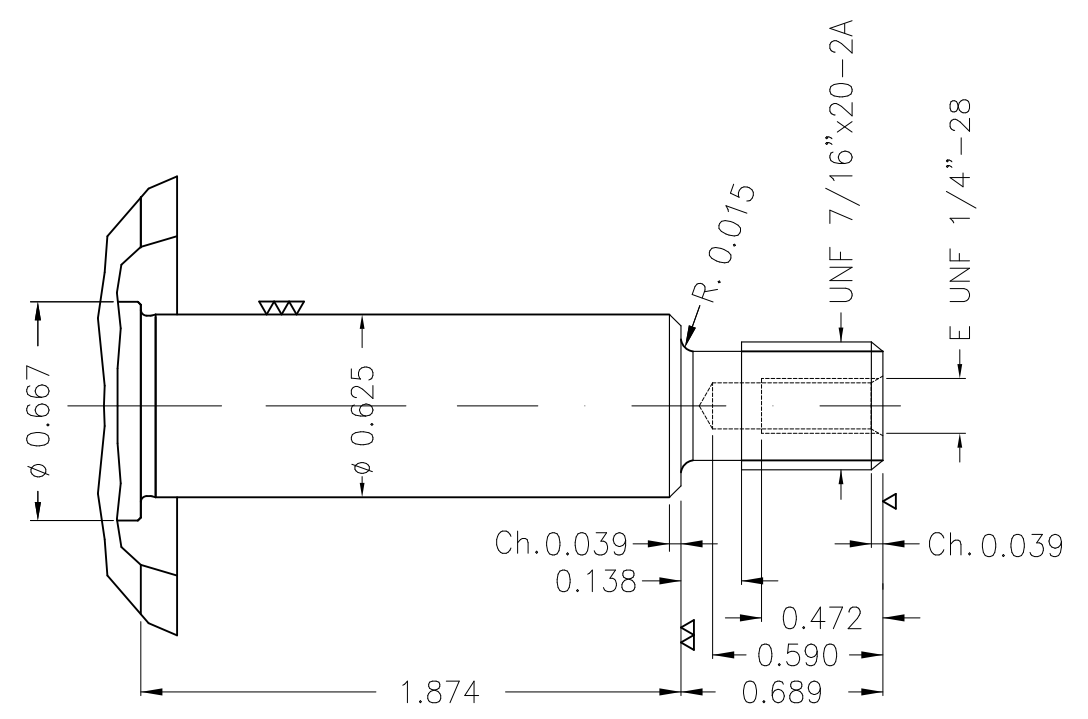
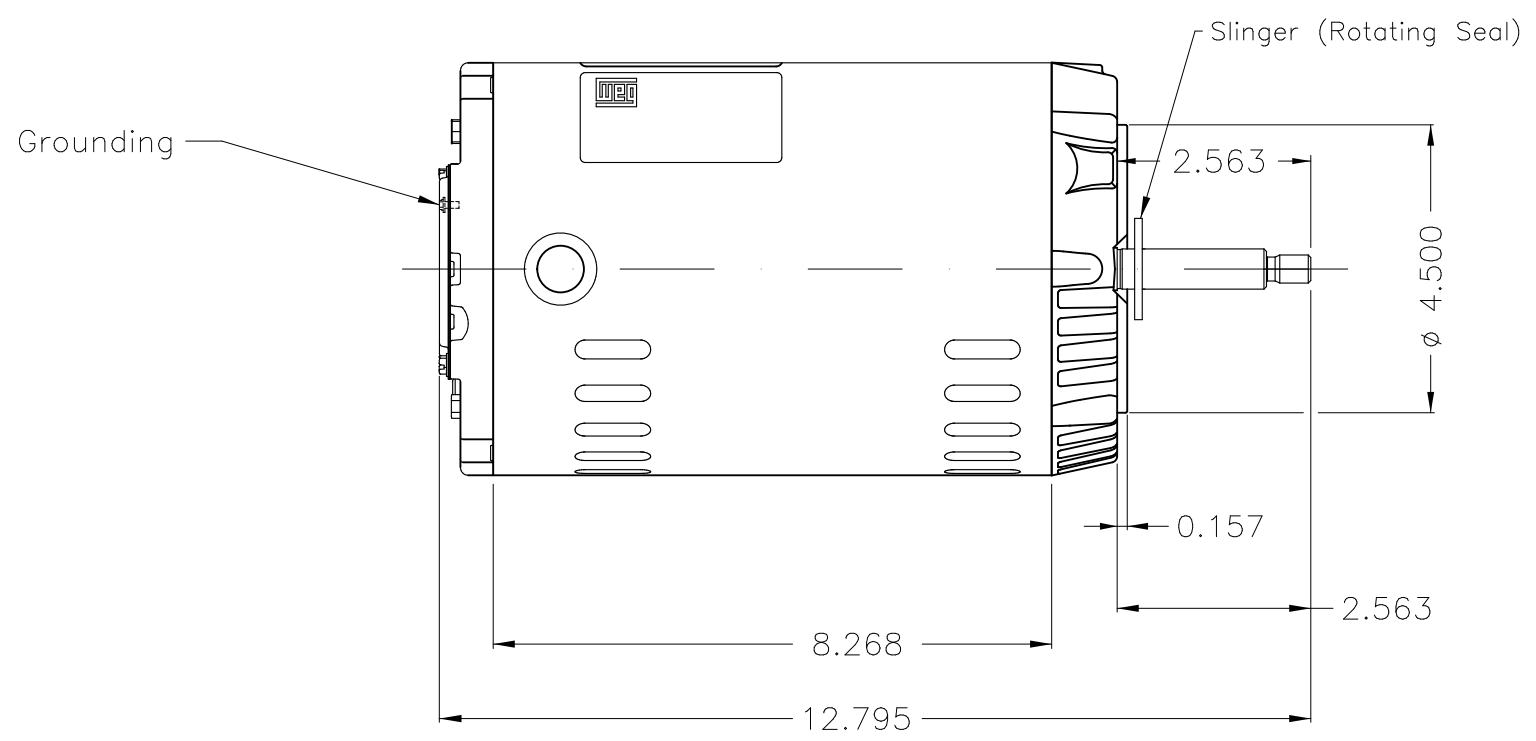
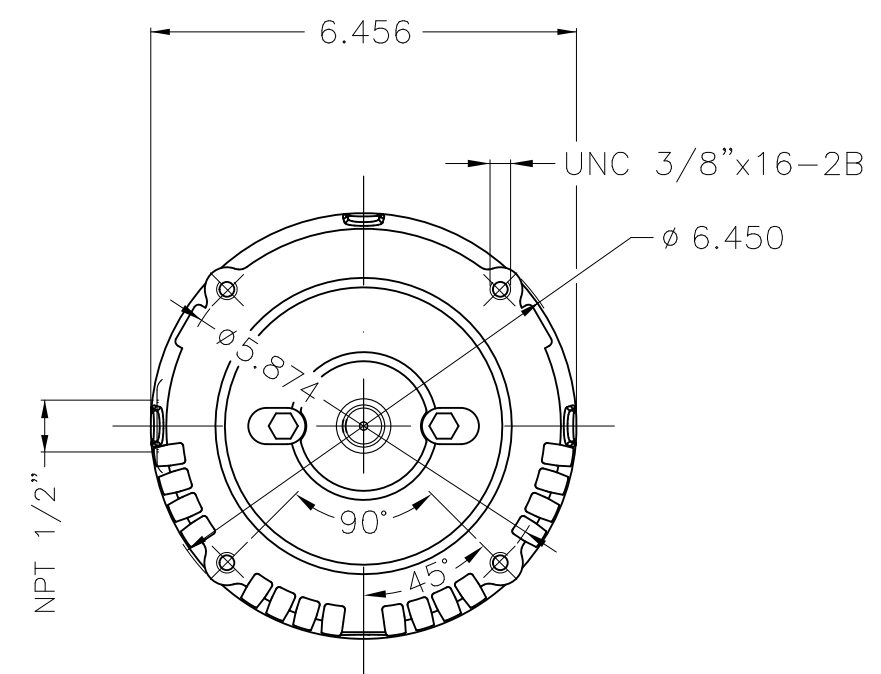

Without coating						
Mounting F-1/B14R(D)						
ECM	LOC	SUMMARY OF MODIFICATIONS	EXECUTED	CHECKED	RELEASED	DATE VER
EXECUTED	USERADMIN	THREE PHASE ODP ROLLED STEEL				
CHECKED		FRAME 56J ODP				
RELEASED		WEG code: 12658481				
REL DT	24.07.2017	WMO Jaragua do Sul	Product Engineering	SHEET	1 / 1	

3 HP 02 Poles 60Hz

A

