

Dimensões em polegada  
Dimensions in inches

THIS IS AN UPDATED REVISION, THE  
PREVIOUS ONE MUST BE DISREGARDED.

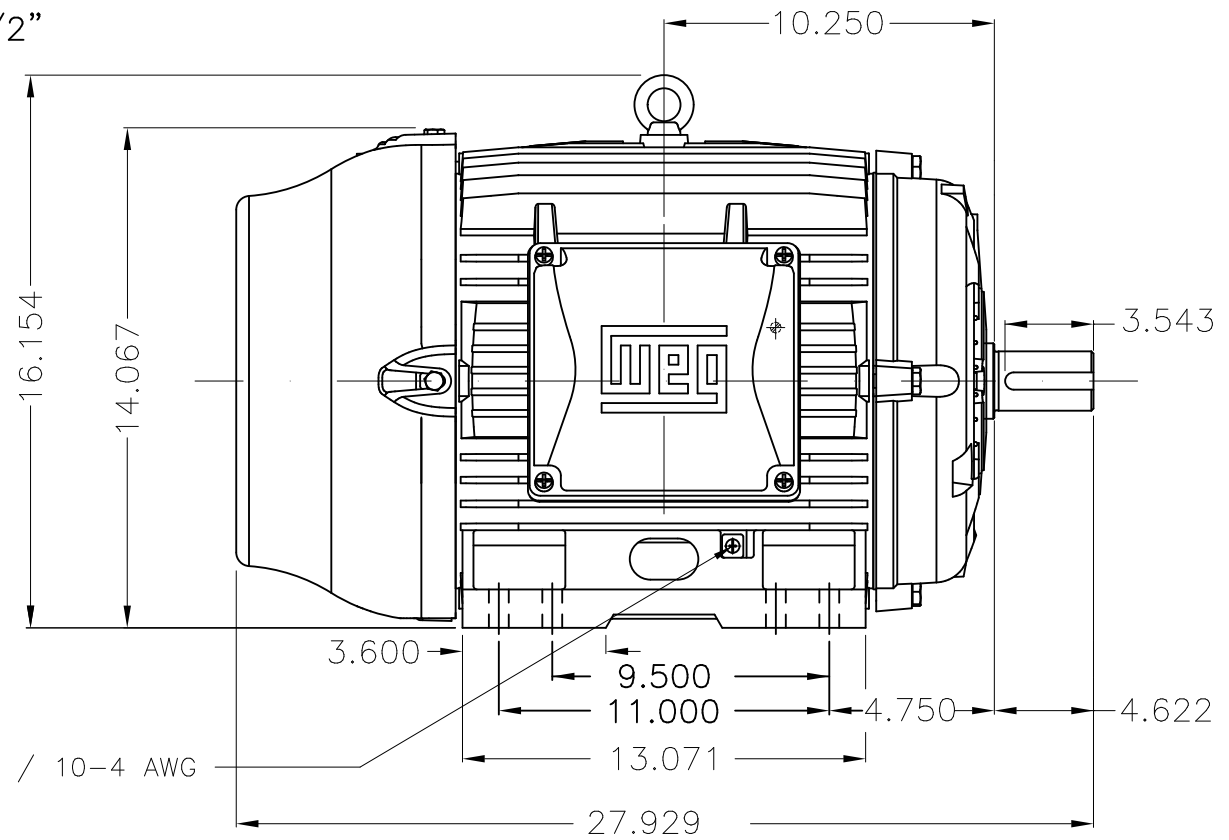

Grounding for leads 5.2–25 mm<sup>2</sup> / 10–4 AWG

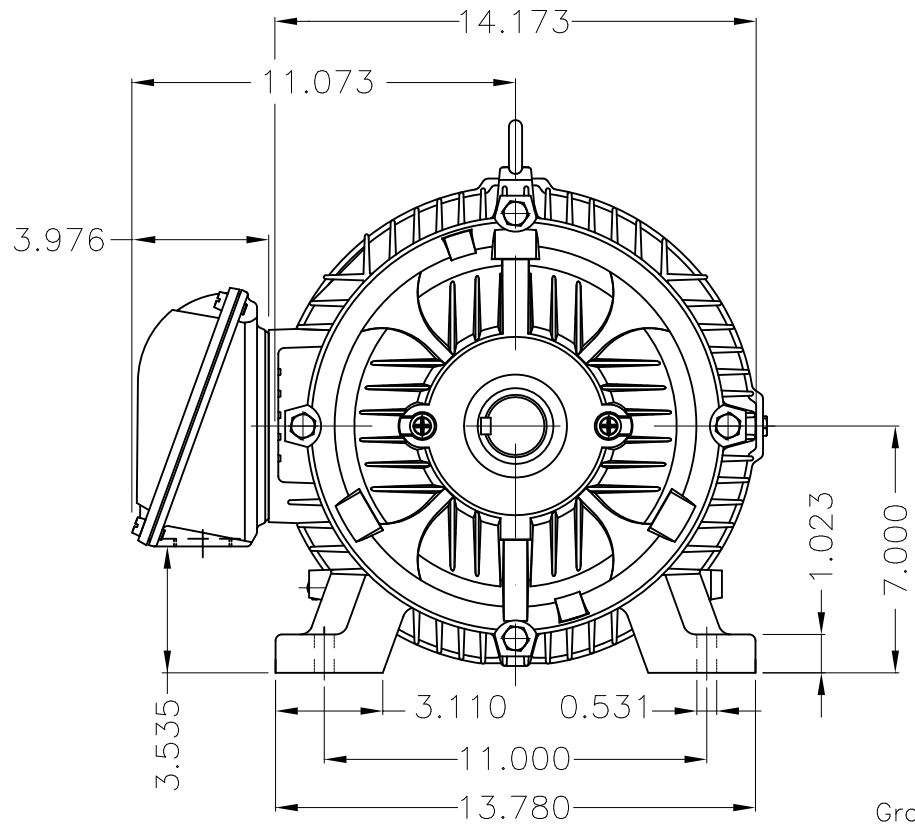

Grounding for leads 5.2–25 mm<sup>2</sup> / 10–4 AWG

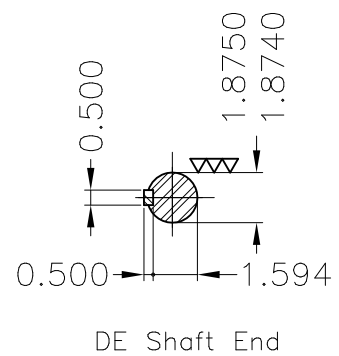

Color RAL 5009  
Painting plan 202E  
Mounting B3R(D)

ECM	LOC	SUMMARY OF MODIFICATIONS			EXECUTED	CHECKED	RELEASED	DATE	VER
EXECUTED	USERADMIN		THREE PH. W22 NEMA P.EFF MOTOR IEEE841						
CHECKED			FRAME 284/6T IP55 TEFC						
RELEASED			WEG code: 12424292						
REL DT	24.07.2017	WMO	Jaragua do Sul	Product Engineering	SHEET	1 / 1			

15 HP 06 Poles 60Hz

