

Dimensional Drawing

Catalogue	Model	HP	Pole	kW	Rating	Voltage	Hz	RPM
RD0012-56	ASGH	1	2	0.75	Continuous	230 / 460 V	60	3600

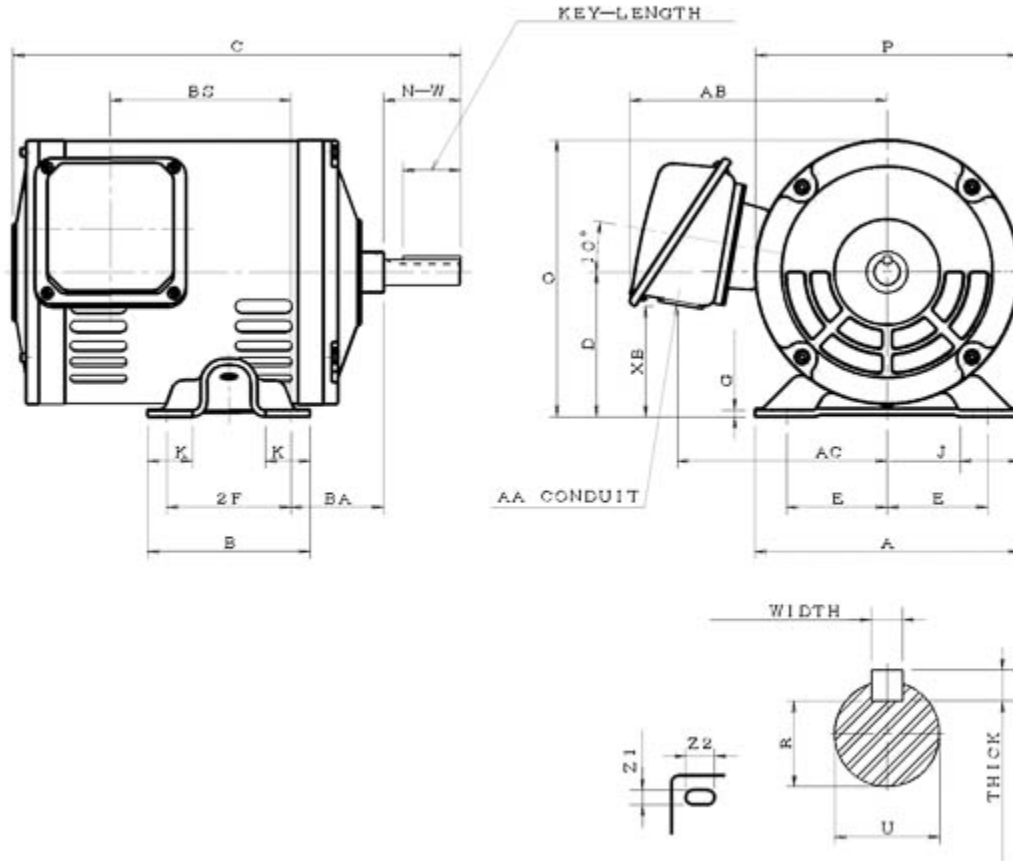

ASGH-SMP-2

Frame Size	Mounting					A	B	C	CD	D	
	E	2F	2F2	H	BA						
56	2.44	3		0.34x0.68	2.75	6.42	4.18	11.84		3.5	
G	J	K	L	M	O	P	T	Key			Keyseat
0.16	1.5	1.46			6.7	6.4		Width	Thick	Length	R
								0.188	0.188	1.41	0.517
Terminal Housing				Aux Box		C/D Flange					
AA	AB	AC	XB	AE	AX	BB	AH	AK	BD	AJ	BF
1.1	6.2	4.93	2.66								
Shaft Extension			Bearings		Approx. Weight Lbs	SPL dBA/3ft	Ins. Class	S.F.	Drive Method	Dimensions	
N-W	U	V	DE	NDE							
1.875	0.625		6205ZZ	6204ZZ	25	58	F	1.15	Direct Coupling / Belt Drive	Inches	

Technical Data Sheet

Motor Type: ASGH

Catalogue No: RD0012-56

Nameplate Information

HP	Pole	RPM	Frame	Voltage	Hz	Phase
1	2	3470	56	230 / 460	60	3
Enclosure	Ins. Class	Service Factor	Time Rating	NEMA Design	Rated Amb.	Rated Altitude
ODP	F	1.15	Continuous	B	-40 to 40 °C	<3300 ft

Typical Performance

Efficiency (%)				Power Factor (%)		
Full Load		3/4 Load	1/2 Load	Full Load	3/4 Load	1/2 Load
Nom.	Min.					
77.0	80.0	81.0	78.0	85.5	78.5	67.5
Torque				Current (A)		
Full Load (lb-ft)	Locked Rotor (% FLT)	Pull Up (% FLT)	Break Down (% FLT)	No Load	Full Load	Locked Rotor
1.51	270	235	320	1.4 / 0.7	2.7 / 1.4	30 / 15
NEMA KVA Code	Inertia (WR ²)			Safe Stall Time (s)		Noise Level Sound Press. dB(A)
	Rotor (lb-ft ²)	NEMA Load (lb-ft ²)	Max. Allowable (lb-ft ²)	Cold	Hot	
N	0.036	1.2	5	30	21	58

VFD Duty Information

Speed Range			VFD		S.F.
Constant Torque	Variable Torque	Constant Power	Carrier	Type	
6-60Hz	3-60Hz	60-120Hz	≤ 5 kHz	VPWM or CPWM	1.0 Only

Additional Information

Bearings		Approx. Weight
DE	NDE	lbs
6205ZZ	6204ZZ	25

Hazardous Locations Information

N/A	
Temp Code (Sinewave / VFD)	/