

Dimensões em polegada
Dimensions in inches

THIS IS AN UPDATED REVISION, THE
PREVIOUS ONE MUST BE DISREGARDED.

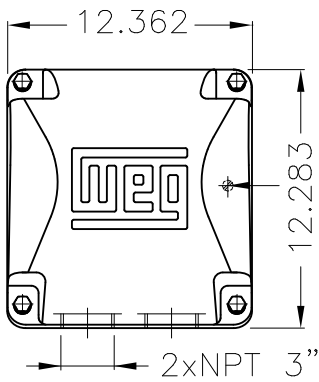

Grounding for leads 35-70 mm² / 1-2/0 AWG

Main terminal box

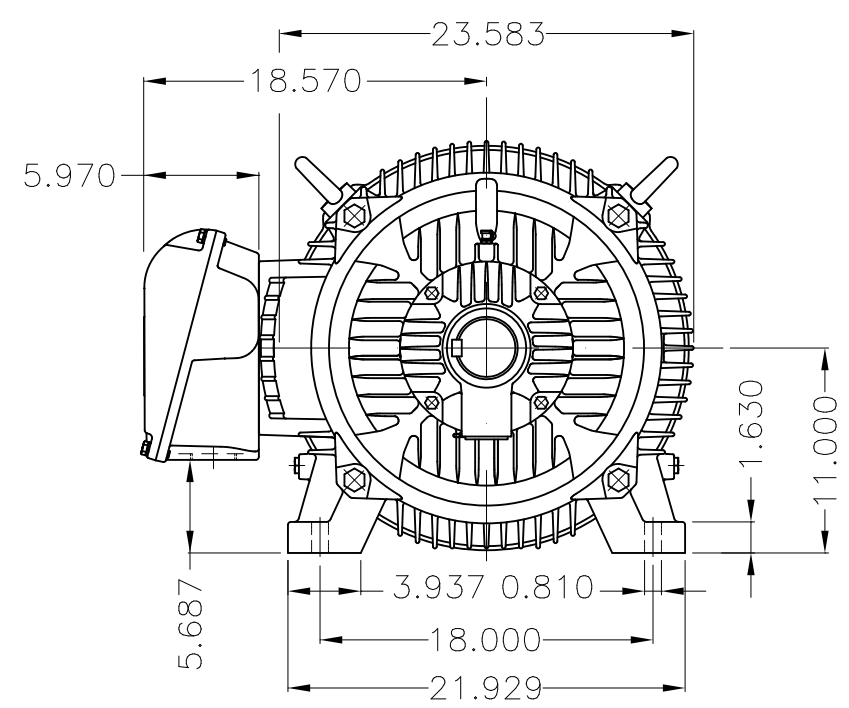

Grounding for leads 25-185 mm² / 3AWG-350MCM

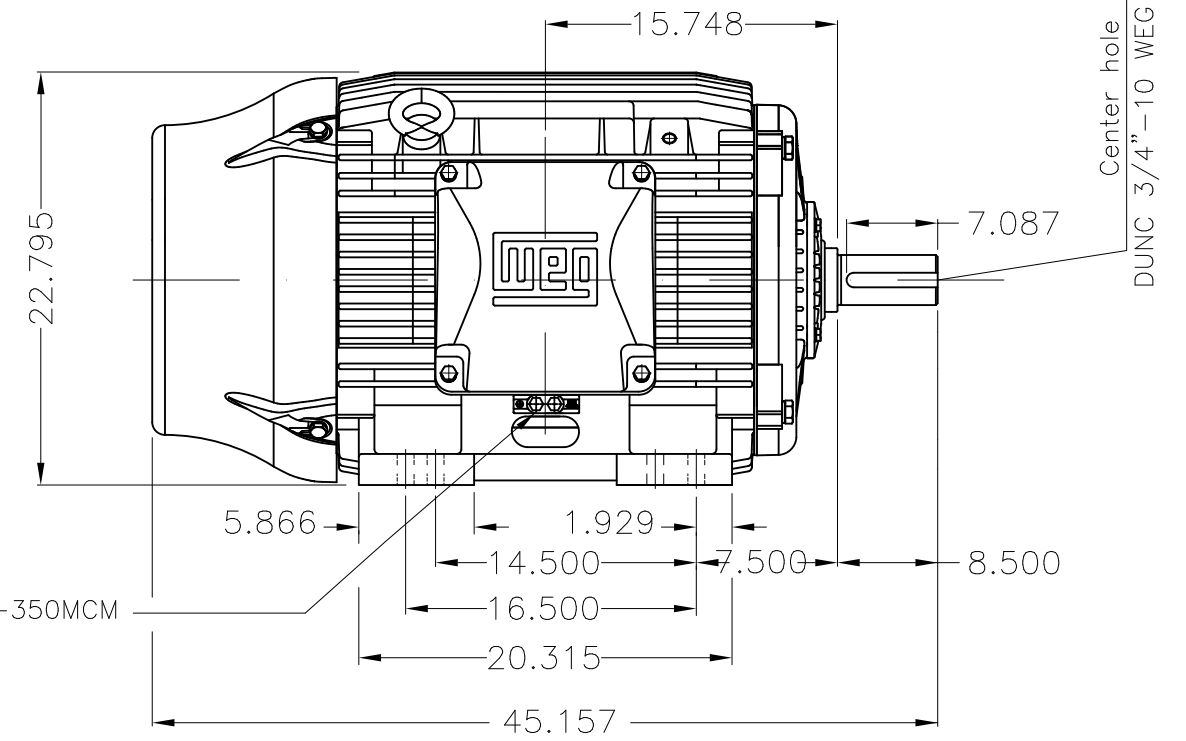

Center hole
DUNC 3/4"-10 WEG TBG12

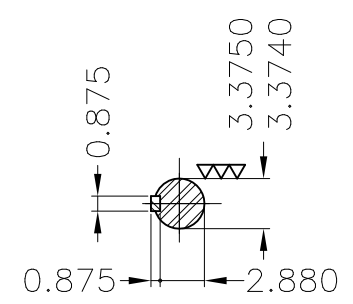

DE Shaft End

Color RAL 5009
Painting plan 202E
Mounting B3R(D)

ECM	LOC	SUMMARY OF MODIFICATIONS	EXECUTED	CHECKED	RELEASED	DATE	VER
EXECUTED	USERADMIN	THREE PH. W22 NEMA P.EFF MOTOR IEEE841					
CHECKED		FRAME 444/5T IP55 TEFC					
RELEASED		WEG code: 11434564					
REL DT	24.07.2017	WMO Jaragua do Sul	Product Engineering	SHEET	1 / 1		

100 HP 06 Poles 60Hz

A

