

Dimensional Drawing

Catalogue	Model	HP	Pole	kW	Rating	Voltage	Hz	RPM
APH0608	AEHH8R	60	8	45	Continuous	460 V	60	900

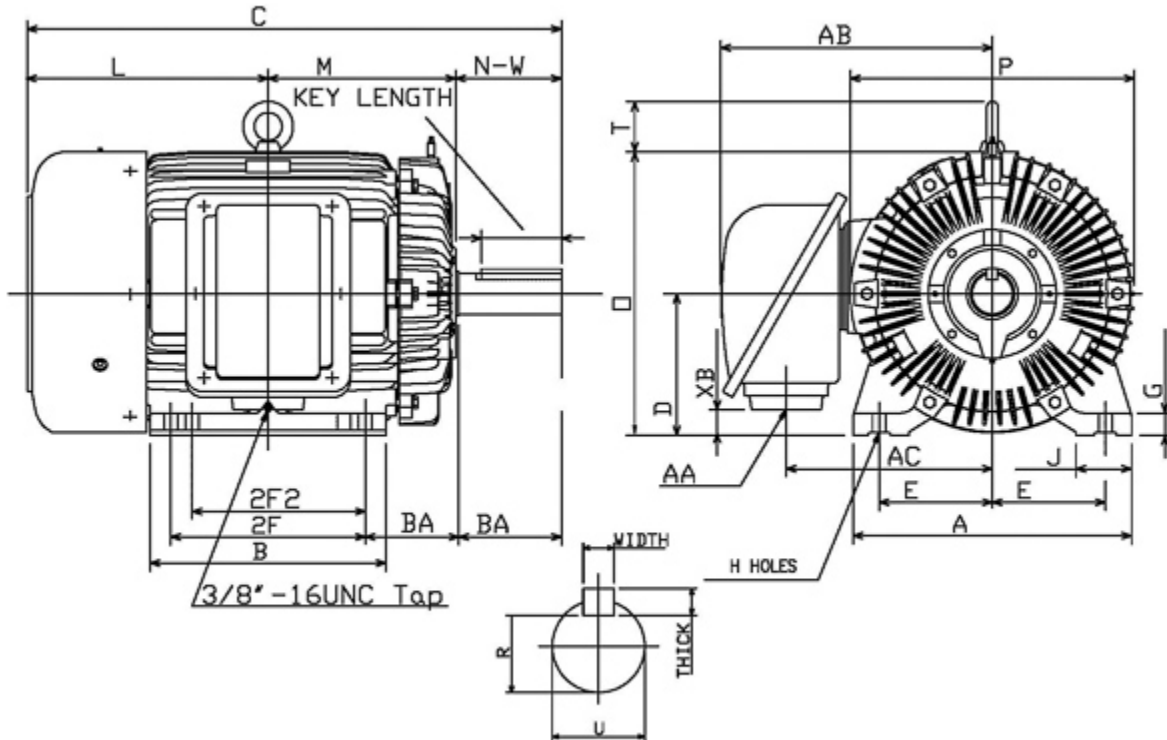

Frame Size	Mounting					A	B	C	CD	D	
	E	2F	2F2	H	BA						
405T	8	13.75	12.25	0.81	6.62	19.68	16.73	37.99		10	
G	J	K	L	M	O	P	T	Key			Keyseat R
								Width	Thick	Length	
1.57	3.94		17.24	13.27	20	20.08	3.54	0.75	0.75	5.65	2.45
Terminal Housing			Aux Box			C/D Flange					
AA	AB	AC	XB	AE	AX	BB	AH	AK	BD	AJ	BF
NPT3"	19.41	14.76	1.81								
Shaft Extension			Bearings		Approx. Weight Lbs	SPL dBA/3ft	Ins. Class	S.F.	Drive Method	Dimensions	
N-W	U	V	DE	NDE							
7.25	2.875	7.16	6317C3	6313ZC3	1298	73	F	1.15	Direct Coupling / Belt Drive	Inches	

Technical Data Sheet

Motor Type: AEHH8R

Catalogue No: APH0608

Nameplate Information

HP	Pole	RPM	Frame	Voltage	Hz	Phase
60	8	885	405T	460	60	3
Enclosure	Ins. Class	Service Factor	Time Rating	NEMA Design	Rated Amb.	Rated Altitude
TEFC	F	1.15	Continuous	B	-40 to 40 °C	<3300 ft

Typical Performance

Efficiency (%)				Power Factor (%)		
Full Load		3/4 Load	1/2 Load	Full Load	3/4 Load	1/2 Load
Nom.	Min.					
93.0	91.7	93.6	93.6	81.0	78.5	70.0
Torque				Current (A)		
Full Load (lb-ft)	Locked Rotor (% FLT)	Pull Up (% FLT)	Break Down (% FLT)	No Load	Full Load	Locked Rotor
356.00	200	175	230	27.6	74.6	435
NEMA KVA Code	Inertia (WR ²)			Safe Stall Time (s)		Noise Level Sound Press. dB(A)
	Rotor (lb-ft ²)	NEMA Load (lb-ft ²)	Max. Allowable (lb-ft ²)	Cold	Hot	
G	32.550	1473	3124	36	25	73

VFD Duty Information

Speed Range			VFD		S.F.
Constant Torque	Variable Torque	Constant Power	Carrier	Type	
6-60Hz	3-60Hz	60-120Hz	≤ 5 kHz	VPWM or CPWM	1.0 Only

Additional Information

Bearings		Approx. Weight
DE	NDE	lbs
6317C3	6313ZC3	1298

Hazardous Locations Information

CSA Certified	
Class I, Div 2, Groups B, C & D	
Class I, Zone 2, Groups IIB+H2, IIB & IIA	
Temp Code (Sinewave / VFD)	T3C / T3A