

Dimensões em polegada
Dimensions in inches

THIS IS AN UPDATED REVISION, THE
PREVIOUS ONE MUST BE DISREGARDED.

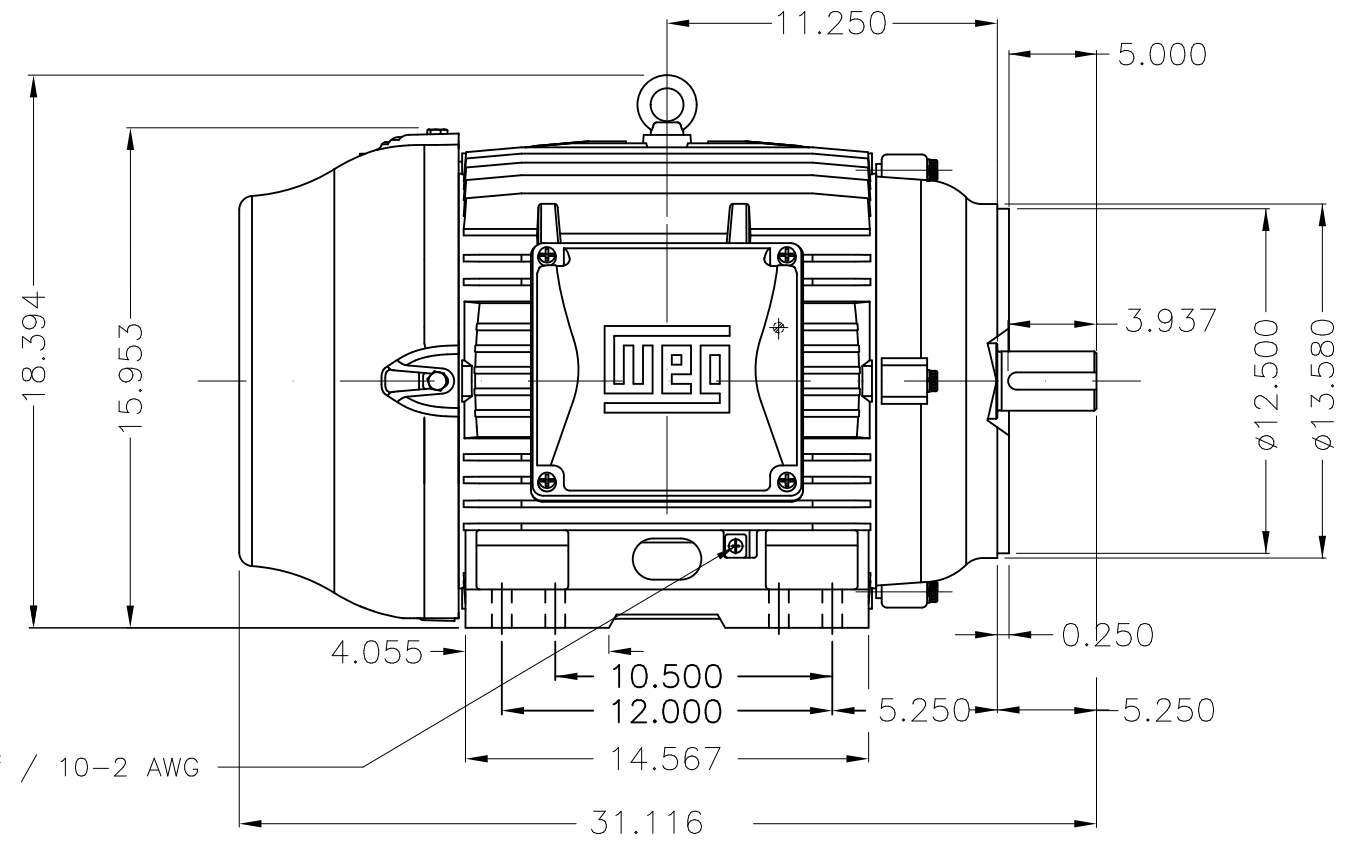

Grounding for leads 5.2–35 mm² / 10–2 AWG

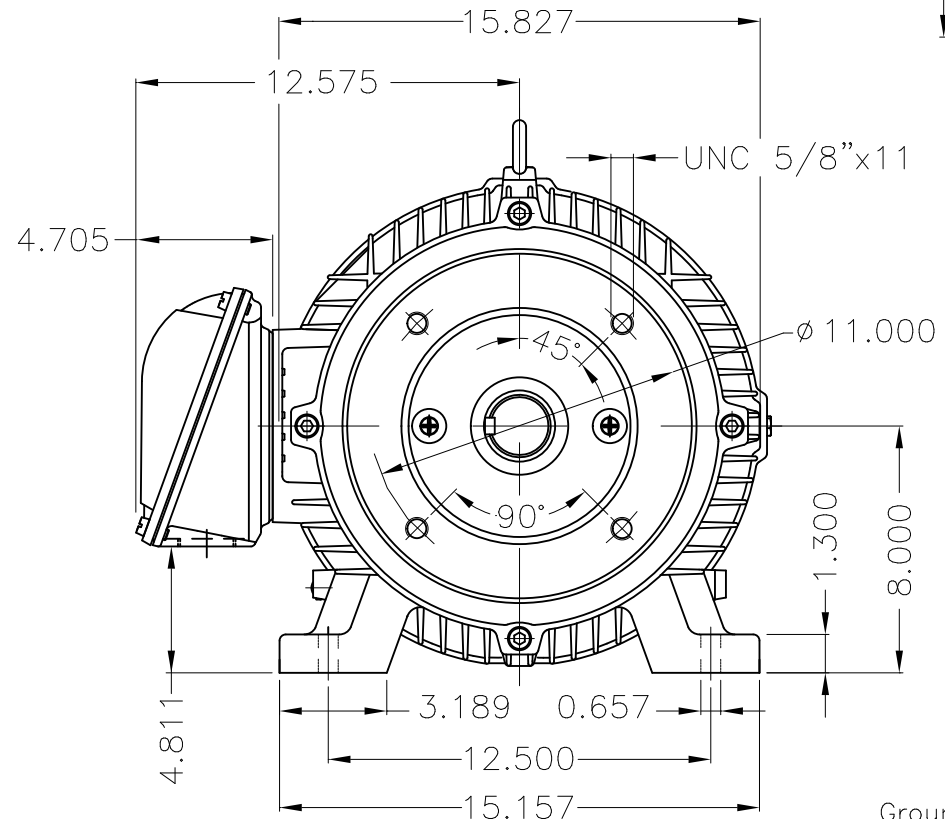

Grounding for leads 5.2–35 mm² / 10–2 AWG

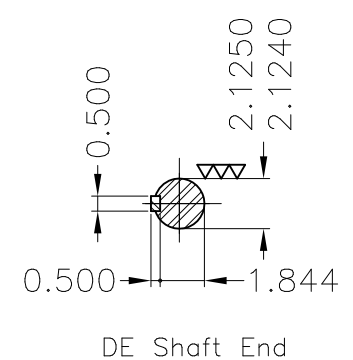

Color RAL 5009
Painting plan 202E
Mounting B34R(D)

ECM	LOC	SUMMARY OF MODIFICATIONS			EXECUTED	CHECKED	RELEASED	DATE	VER
EXECUTED	USERADMIN		THREE PH. W22 NEMA P.EFF MOTOR IEEE841						
CHECKED			FRAME 324/6TC IP55 TEFC						
RELEASED			WEG code: 11431990						
REL DT	24.07.2017	WMO	Jaragua do Sul	Product Engineering	SHEET	1 / 1			

50 HP 04 Poles 60Hz

A

