

Product Information Packet

January 12, 2017

Data shown is for the current revision model #. Ensure your nameplate model # matches.

Model Number:	5KS511SAA339C
Catalog Number:	Q517
Instruction Manual:	GEI-56128
Connection Diagram:	GEM2034E-FIG2
Outline Drawing:	239C6B00MD

Accessory Connection Diagrams			
Bearing Thermocouple:	None	Heater:	3027JE-1C
RTD:	235A3027XY	Thermistor:	None
Thermostat:	None	Winding Thermocouple:	None
Bearing RTD:	235A3027NA		

Table of Contents	
Specification	01
Performance Characteristics	02
Outline Drawing	03
Connection Drawing(s)	04



Marks:

MODEL NUMBER:	5KS511SAA339C	Estimated Weight:	5742 Lbs
Outline Drawing:	239C6B00MD	Time Rating:	CONT
Connection Diagram:	GEM2034E-FIG2	Enclosure:	TEFC
Instruction Book:	GEI-56128	Encl Construction:	SD
Design Code:	50BD3116F	Ambient Max(°C):	40
Type:	KS	Alt Ambient Max(°C):	--
Frame:	5011L	Insulation Class:	F
Phases:	3	NEMA Design:	B
Poles:	6	Nominal Efficiency:	95.0 %
Output Power:	350HP 259KW	Guaranteed Efficiency:	94.1
RPM:	1190	3/4 Load Efficiency:	96.1
Voltage:	2300/4000	KVA Code:	G
Hertz:	60	Max KVAR:	86.3
Amps - FL:	79.7/45.8	Power Factor:	86.5
Service Factor:	1.15	Bearing - DE:	NU 320
Alt Service Factor:	--	Bearing - ODE:	6315ZC3

Enclosure is Totally Enclosed Fan-Cooled

Stamped Nameplate Notes:

HTR LDS HE1-HE2 115V 350W
ROLLER BEARING - FOR BELTED LOAD ONLY

Additional Information:

6P - L EXTN
2500 CU IN - 2(4.00" NPT)
B5F4C4 HIGH STRENGTH STEEL AISI 4142 SHAFT MATERIAL
100 OHM WINDING RTD LEADS TO AUX C/BOX OPP MAIN C/BOX
SUGGESTED WINDING RTD SETTINGS
ALARM 165C TRIP 175C
115V HTR LDS TO AUX BOX OPP MAIN CONDUIT BOX
SPACE HEATER CAUTION NAMEPLATE
BEARING RTD 100 OHM ON BOTH ENDS
SUGGESTED BEARING RTD SETTINGS
ALARM 115C TRIP 125C
NEMA TYPE GRD PAD
F1 MOUNTING
SHAFT BLOCKING FOR SHIPMENT

Performance Characteristics

1st Winding 1st Connection

Design: 50BD3116F

Marks:

LOAD %	125.0	115.0	100.0	75.0	50.0	25.0	0.0
% EFF	95.12	95.38	95.91	96.06	95.95	94.25	0.00
% PF	86.72	86.72	86.28	83.84	76.81	56.37	3.46
AMPS	57.08	52.37	45.54	35.08	25.56	17.73	13.83

TORQ(FL)#FT	1546.14	TORQ(LR)%FL	115.82	TORQ(BD)%FL	250.69
AMPS(LR)	275.16	PF AT START	0.26		

This motor is capable of two cold or one hot start with a maximum connected load inertia of 13027 Lb-Ft Sq (548.44 Kg-meter Sq)at 100% voltage, where the load torque varies with the square of the speed. Acceleration time with maximum inertia and the above load type is 33 seconds. Safe stall time at 100% voltage is 117 seconds cold, 60 seconds hot. Rotor inertia is 271.36 Lb-Ft Sq (11.42 Kg-meter Sq).

Open Circuit A-C:	0.904	Short Circuit D-C:	0.029
Short Circuit A-C:	0.043	X/R Ratio:	11.116
Stator Slots:	72	Rotor Slots:	58

Speed Torque Current Curve (First Connection, First Speed)

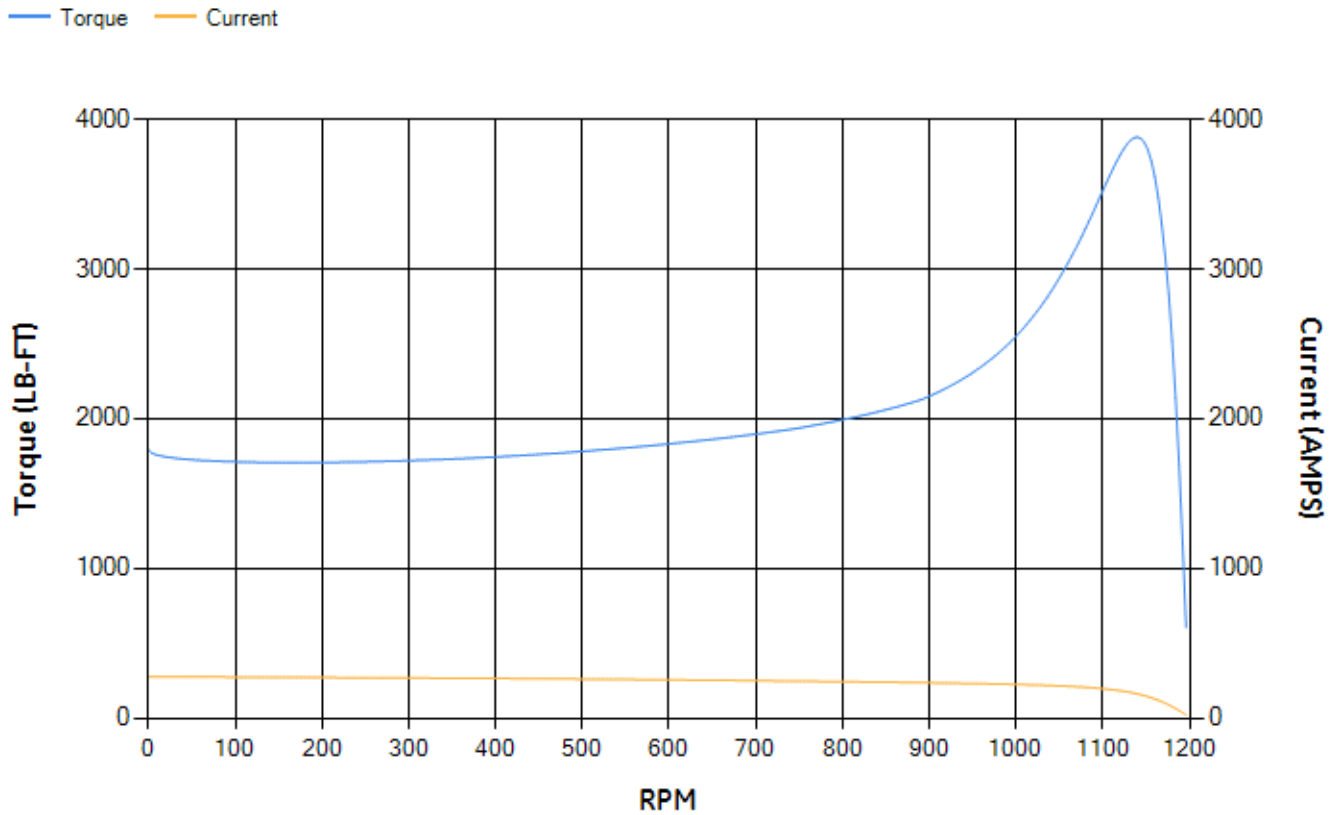

Marks:

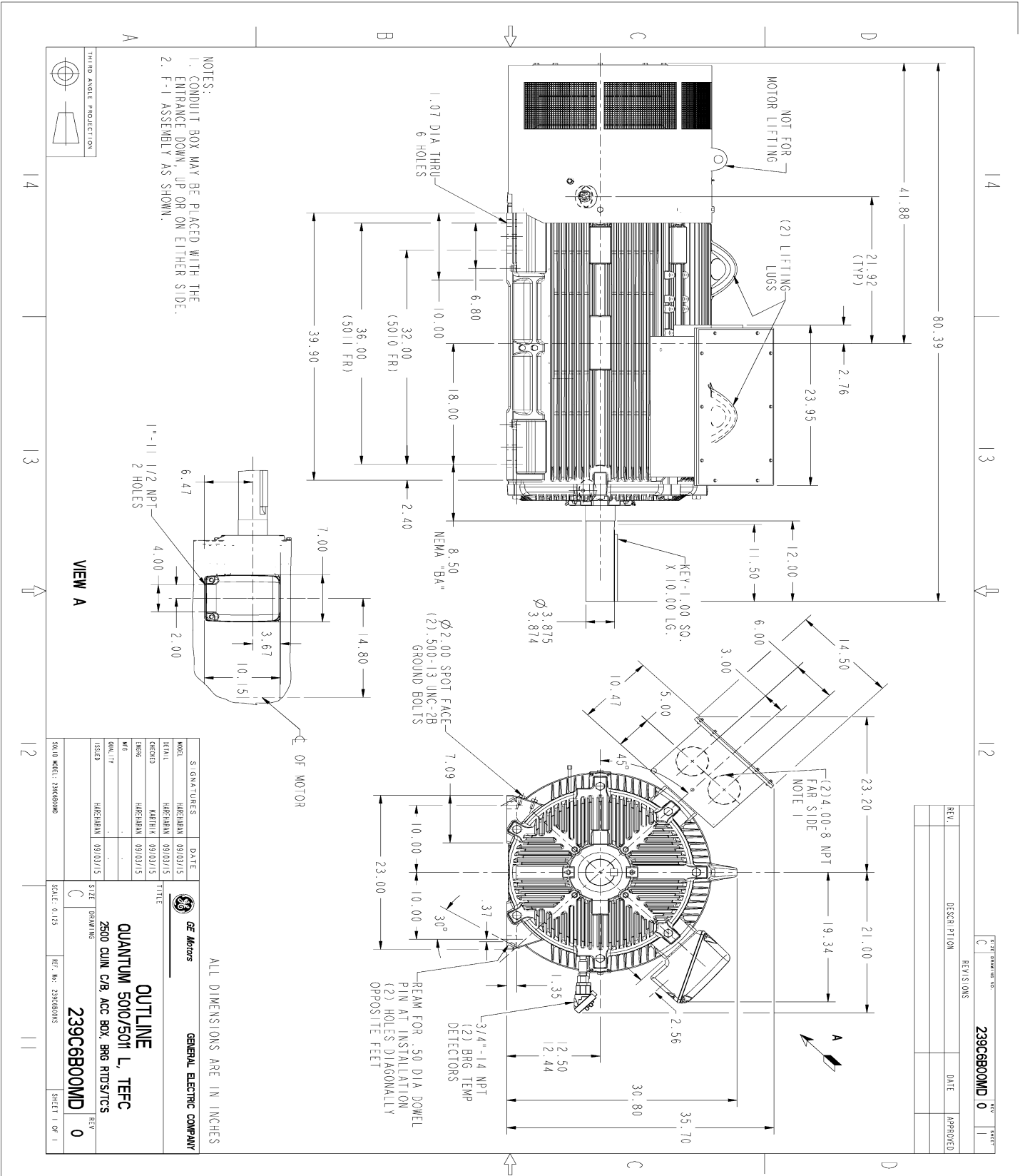

REV.	DESCRIPTION	DATE	APPROVED

SIGNATURES	DATE
HAEGBAN	09/03/15
HAEGBAN	09/03/15
HAEGBAN	09/03/15
HAEGBAN	09/03/15
HAEGBAN	09/03/15
HAEGBAN	09/03/15

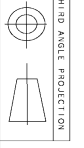

Marks:

Connection Diagram
GEM2034E-FIG2

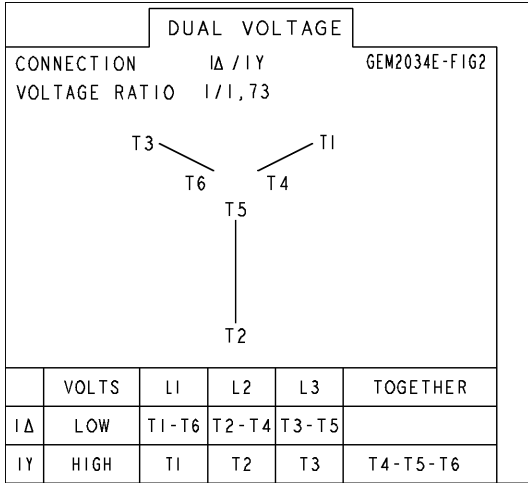

Heater Connection
3027JE-1C

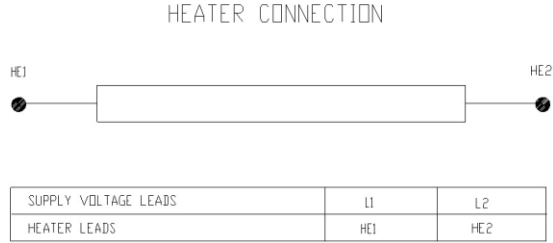

GE PROPRIETARY INFORMATION

This document is the property of General Electric Company ("GE") and contains proprietary information of GE. This document is loaned on the express condition that neither it nor the information contained therein shall be disclosed to others without the express written consent of GE Industrial Systems, and that the information shall be used by the recipient only as approved expressly by GE Industrial Systems. This document shall be returned to GE upon its request. This document may be subject to certain restrictions under U.S. export control laws and regulations.

THIRD ANGLE PROJECTION

REVISIONS				
REV.	DESCRIPTION	DATE	APPROVED	
1	ISAAC# 15-0790 HARIKIRAN	07/28/15	DHEERAJ	
2	ISAAC# 16-0422 SAGAR K	05/04/2016	ADINARAYANA	

REV 2

SIZE DRAWING NO. A

235A3027XY

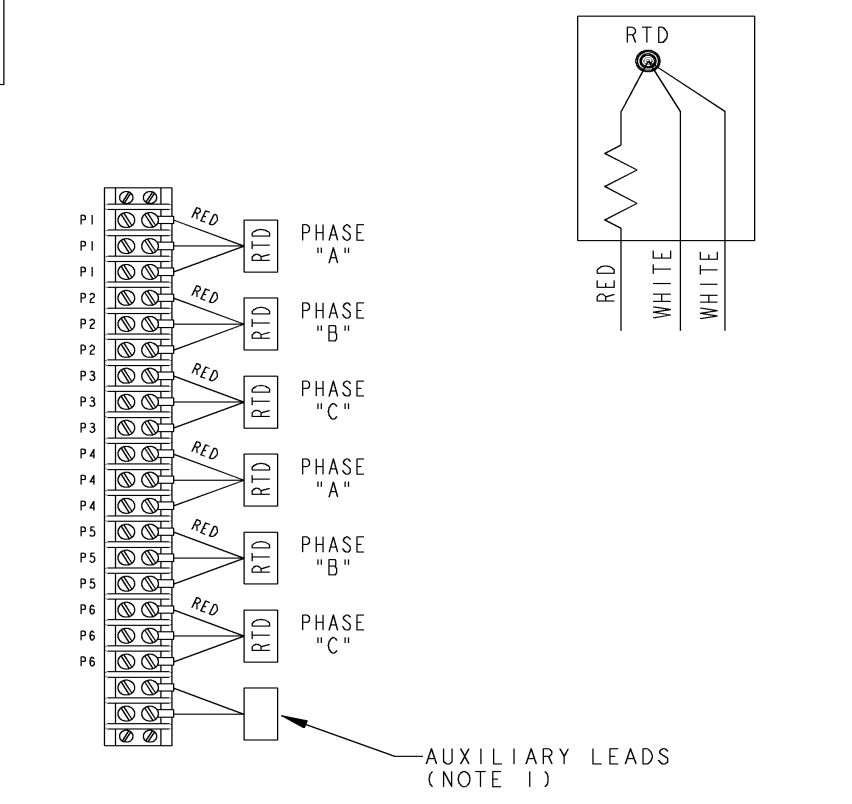

NOTE 1: AUXILIARY LEADS SHOWN MAY OR MAY NOT BE PROVIDED IN MOTOR.
 NOTE 2: SPARE RTDS (P7 & P8) FURNISHED IN CASE OF FAILURE IN OTHER RTDS (P1-P6). PHASE LOCATION WILL DEPEND UPON NUMBER OF POLES WINDING CONFIGURATION.

Part must conform to SI 900000 Sect. 4, Toxicity Procedure

FOR ADDITIONAL INFO REFER TO:		SIGNATURES		DATE	GE Motors GENERAL ELECTRIC COMPANY
APPLIED PRACTICES		MODEL			
DIMENSIONS ARE IN INCHES		DETAIL	VIVEK	06/26/15	TITLE CONNECTION DIAGRAM WINDING RTD & AUXILIARY LEADS
TOLERANCE ON:		CHECKED	KARTHIK	06/26/15	
1 PL DECIMALS ± 0.1		ENGRG			
2 PL DECIMALS ± 0.02		MFG			
3 PL DECIMALS ± 0.005		QUALITY			SIZE DRAWING 235A3027XY
ANGLES ± 0.5		ISSUED	VIVEK	06/26/15	
FRACTIONS ±					REV 2
FINISH ✓		SOLID MODEL: MODEL NAME		SCALE: N.T.S.	REF: - 235A4594X
MATERIAL				SHEET 1 of 1	



REV 1 SH SIZE A DWG NO 235A3027NA	THIRD ANGLE PROJECTION		REVISIONS			
			REV	DESCRIPTION	DATE	APPROVED
	1	ISAAC #12-1124	HARI	11/19/12	KARTHIK	

CONFIDENTIAL AND PROPRIETARY

This document is the property of General Electric Company and contains proprietary and confidential information of the Motor Business Group (MBG). The document is loaned on the express conditions that neither it nor the information contained therein shall be disclosed to others without the express consent of MBG and that the information shall be used by the recipient only as approved expressly by MBG. Also, the document shall be returned to MBG upon its request.

BEARING RTDS

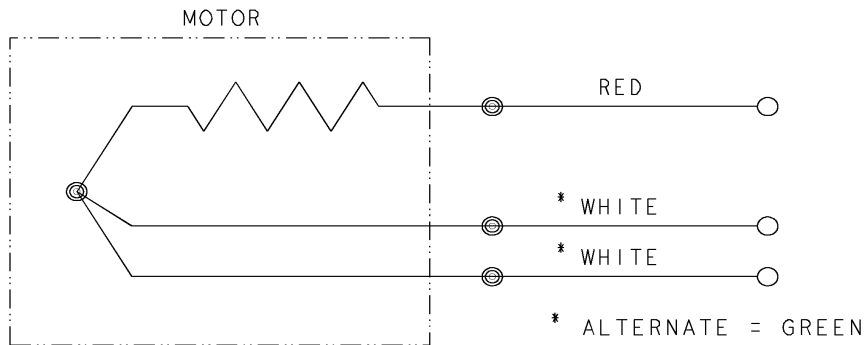

UNLESS OTHERWISE SPECIFIED DIMENSIONS ARE IN INCHES TOLERANCES ON: 2 PL DECIMALS ± 3 PL DECIMALS ± ANGLES ± FRACTIONS ± MATERIAL: APPLIED PRACTICES:	SIGNATURES	DATE	Fort Wayne, Indiana		
	DRAWN D.E. BAIR	12/16/92			
	CHECKED D.E. BAIR	12/16/92			
	ENGRG K. DESAI	12/16/92			
ISSUED D.E. BAIR	12/16/92				
CAD NO. F500:235A3027NA	SIZE A	FSCM NO	DWG NO 235A3027NA	DISTR TO	
SCALE 1/1	SHEET 1 OF 1				

