

Dimensões em polegada  
Dimensions in inches

THIS IS AN UPDATED REVISION, THE  
PREVIOUS ONE MUST BE DISREGARDED.

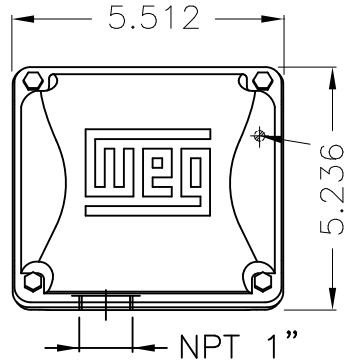

Main terminal box

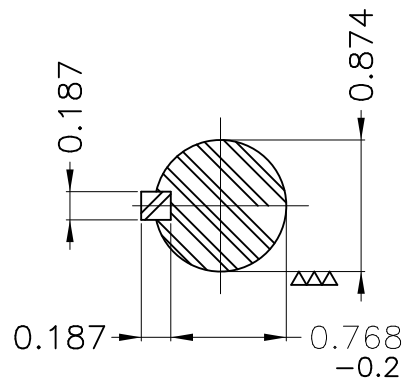
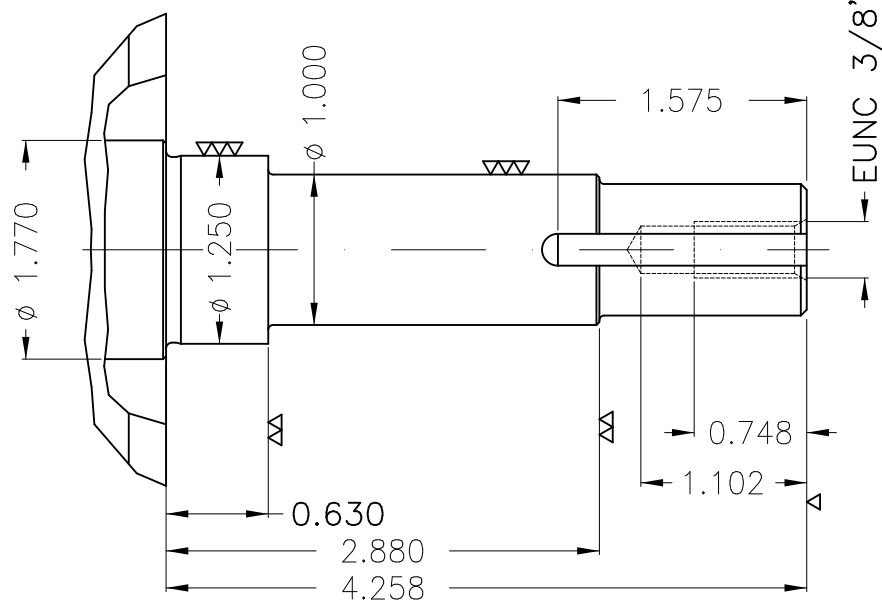
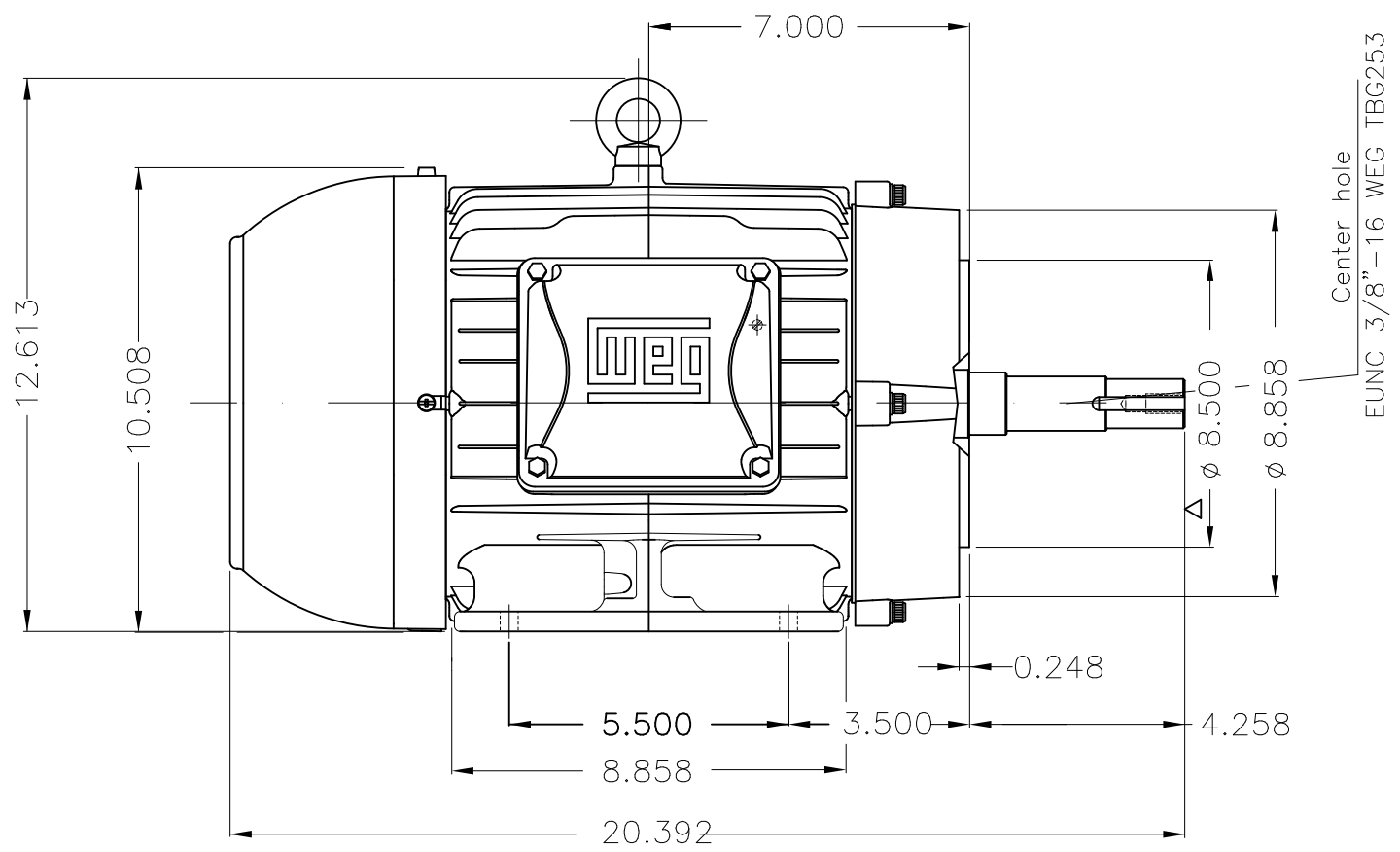
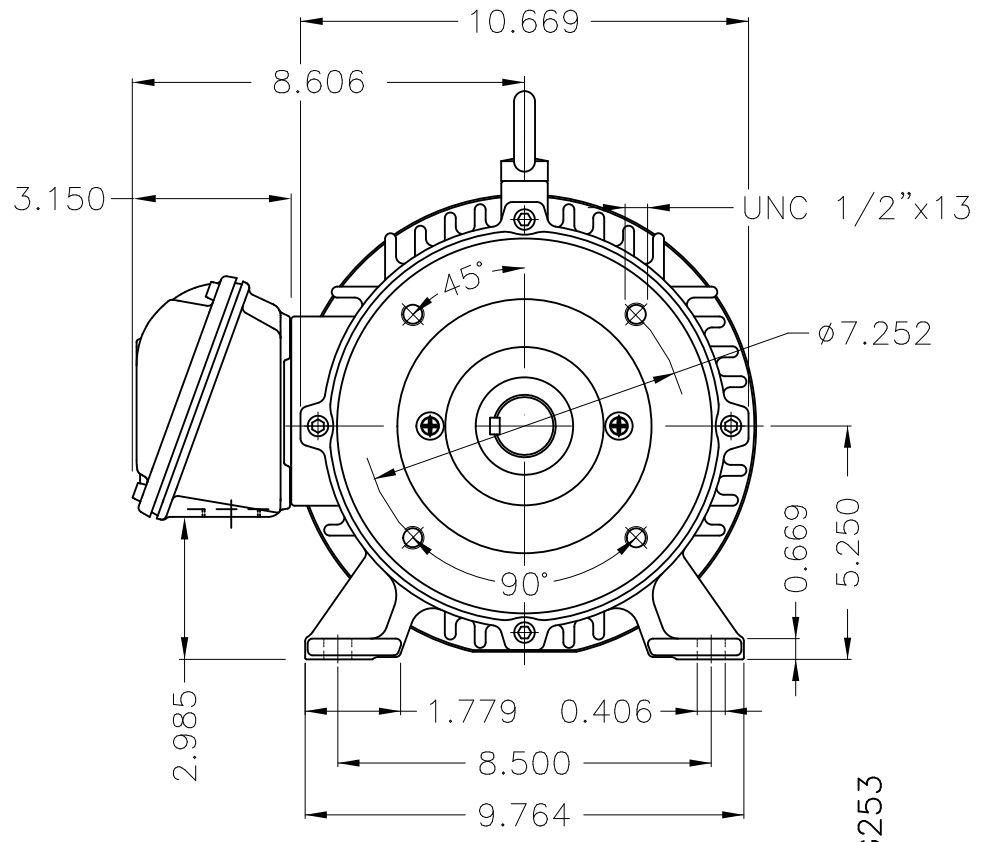

15 HP 02 Poles 60Hz

Color RAL 5009  
Painting plan 207A  
Mounting B34R(D)

ECM	LOC	SUMMARY OF MODIFICATIONS	EXECUTED	CHECKED	RELEASED	DATE	VER
EXECUTED	USERADMIN	THREE PHASE MOTOR W22 NEMA PREMIUM EFF.					
CHECKED		FRAME 213/5JM IP55 TEFC					
RELEASED		WEG code: 12119370					
REL DT	24.07.2017	WMO Jaragua do Sul	Product Engineering	SHEET	1 / 1		

