

DATE
OCTOBER 29, 2009
CAT. #: GPV0034C

OUTLINE DIMENSIONS
3-PHASE INDUCTION MOTOR

MOTOR TYPE:
AETHCF
FRAME NO. 182TC

Pole	HP	kW	Hz	VOLT	Syn.Speed r/min(rpm)
4	3	2.2	60	230/460	1800

Ins	Rating	Dimension in	Approx Weight	Bearings
F	CONT.	inches	69 lbs.	DE:6206ZZC3 NDE:6205ZZC3

Totally Enclosed Fan-Cooled Type, Squirrel-Cage Rotor.

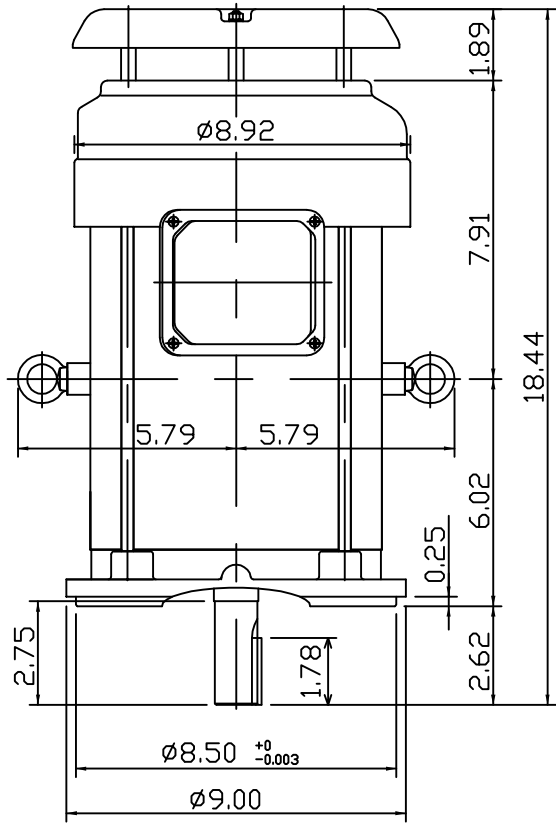

Ø1.10" CONDUIT HOLE

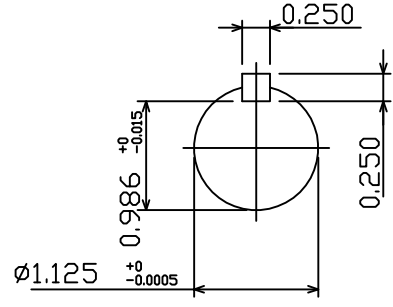
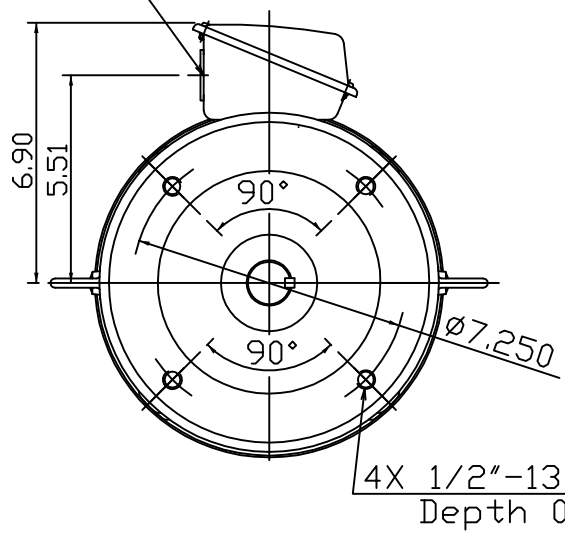

DWN.	Y.S.LIN	10 04 09
CHKD.	J.H.LIANG	10 06 09
APPD.	M.C.TSAI	10 06 09



DWG NO.
31049R194010