

Dimensões em polegada  
Dimensions in inches

THIS IS AN UPDATED REVISION, THE  
PREVIOUS ONE MUST BE DISREGARDED.

Grounding for leads 5.2–25 mm<sup>2</sup> / 10–4 AWG

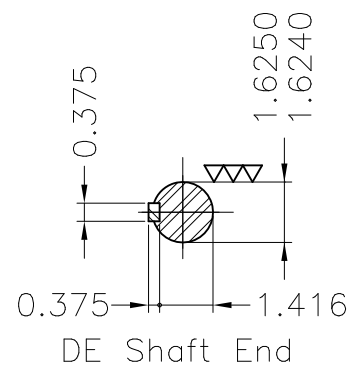
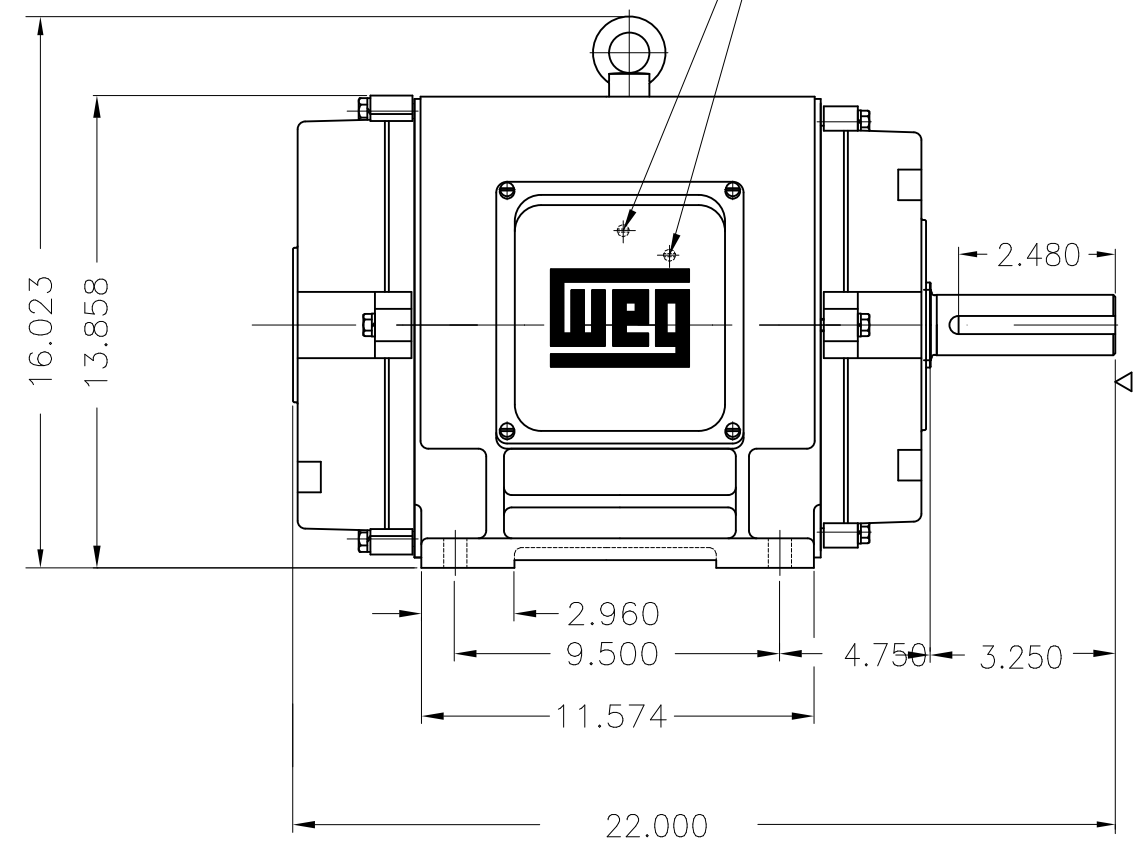
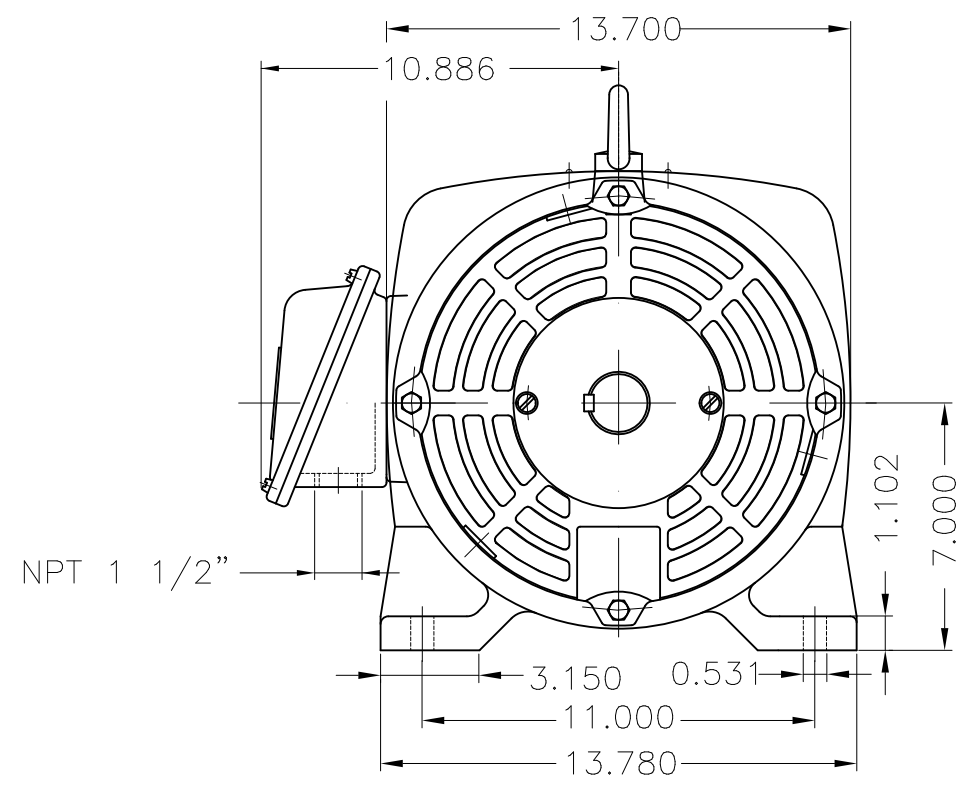

TS shaft end  
Color RAL 5009  
Painting plan 203A  
Mounting B3R(D)

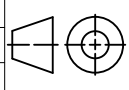
ECM	LOC	SUMMARY OF MODIFICATIONS	EXECUTED	CHECKED	RELEASED	DATE	VER
EXECUTED	USERADMIN	 THREE PHASE NEMA P. EFF MOTOR FRAME 284TS IP23 ODP WEG code: 10730870					
CHECKED							
RELEASED							
REL DT	24.07.2017	WMO Jaragua do Sul	Product Engineering	SHEET	1 / 1		

25 HP 04 Poles 60Hz

A

