

**Dimensional Drawing**

Catalogue	Model	HP	Pole	kW	Rating	Voltage	Hz	RPM
VCN07565	AMRCNH	75	6	56	Continuous	575 V	60	1200

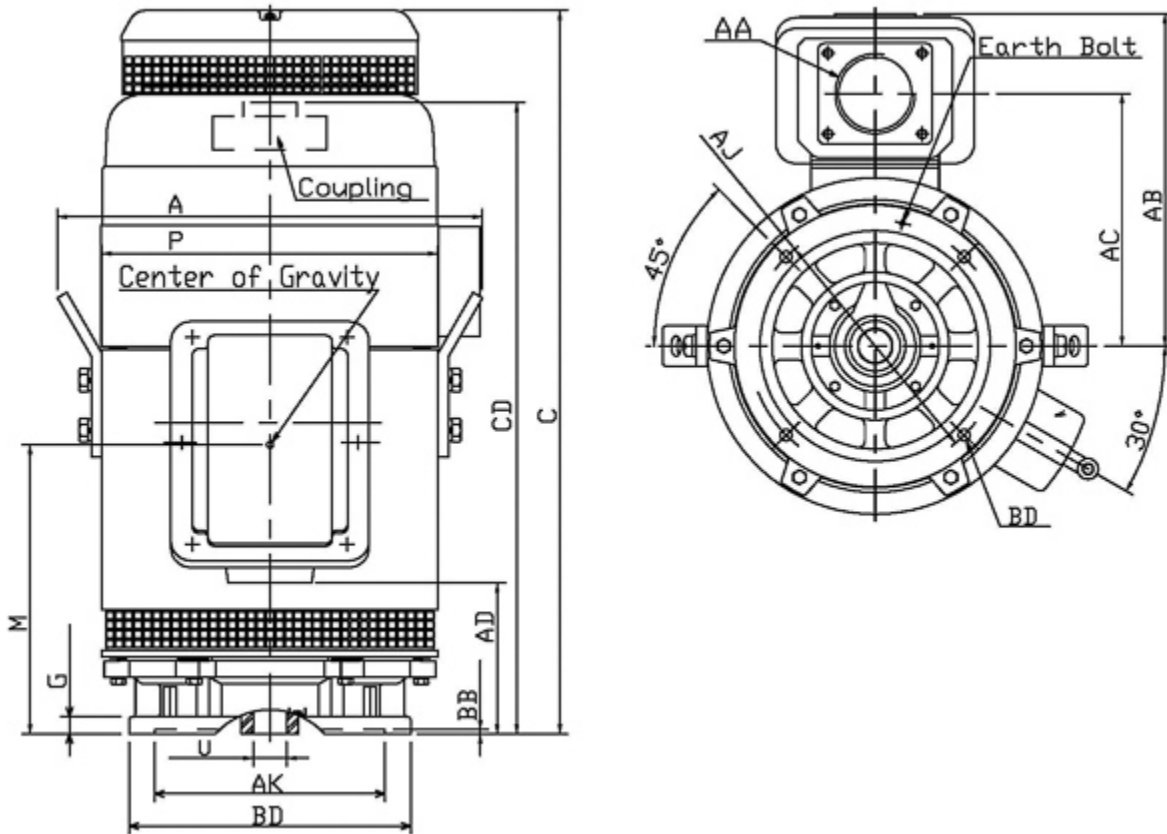

Frame Size	Mounting					A	B	C	CD	D	
	E	2F	2F2	H	BA						
405TP						24.88		42.32	36.94		
G	J	K	L	M	O	P	T	Key			Keyseat
						19.69		Width	Thick	Length	R
Terminal Housing				Aux Box		C/D Flange					
AA	AB	AC	XB	AE	AX	BB	AH	AK	BD	AJ	BF
3" NPT	19.41	14.76				0.28		13.5	16.5	14.75	0.69
Shaft Extension			Bearings		Approx. Weight Lbs	SPL dBA/3ft	Ins. Class	S.F.	Drive Method	Dimensions	
N-W	U	V	DE	NDE							
	2		6315C3	7322B	1215	0	F	1.15	Direct Coupling	Inches	

### Technical Data Sheet

Motor Type: AMRCNH

Catalogue No: VCN07565

#### Nameplate Information

HP	Pole	RPM	Frame	Voltage	Hz	Phase
75	6	1180	405TP	575	60	3
Enclosure	Ins. Class	Service Factor	Time Rating	NEMA Design	Rated Amb.	Rated Altitude
WPI	F	1.15	Continuous	B	-40 to 40 °C	<3300 ft

#### Typical Performance

Efficiency (%)				Power Factor (%)		
Full Load		3/4 Load	1/2 Load	Full Load	3/4 Load	1/2 Load
Nom.	Min.					
94.5	93.6	95.0	94.5	86.5	85.5	79.0
Torque				Current (A)		
Full Load (lb-ft)	Locked Rotor (% FLT)	Pull Up (% FLT)	Break Down (% FLT)	No Load	Full Load	Locked Rotor
333.70	220	200	250	20.5	68.7	434
NEMA KVA Code	Inertia (WR <sup>2</sup> )			Safe Stall Time (s)		Noise Level Sound Press. dB(A)
	Rotor (lb-ft <sup>2</sup> )	NEMA Load (lb-ft <sup>2</sup> )	Max. Allowable (lb-ft <sup>2</sup> )	Cold	Hot	
G	31.371	904	1317	17	12	0

#### VFD Duty Information

Speed Range			VFD		S.F.
Constant Torque	Variable Torque	Constant Power	Carrier	Type	
0	22.5-60Hz:	0	≤ 3 kHz	VPWM or CPWM	1.0 Only

#### Additional Information

Bearings		Approx. Weight
DE	NDE	lbs
6315C3	7322B	1215

#### Hazardous Locations Information

0	
0	
0	
Temp Code (Sinewave / VFD)	0 / 0