

Dimensões em polegada
Dimensions in inches

THIS IS AN UPDATED REVISION, THE
PREVIOUS ONE MUST BE DISREGARDED.

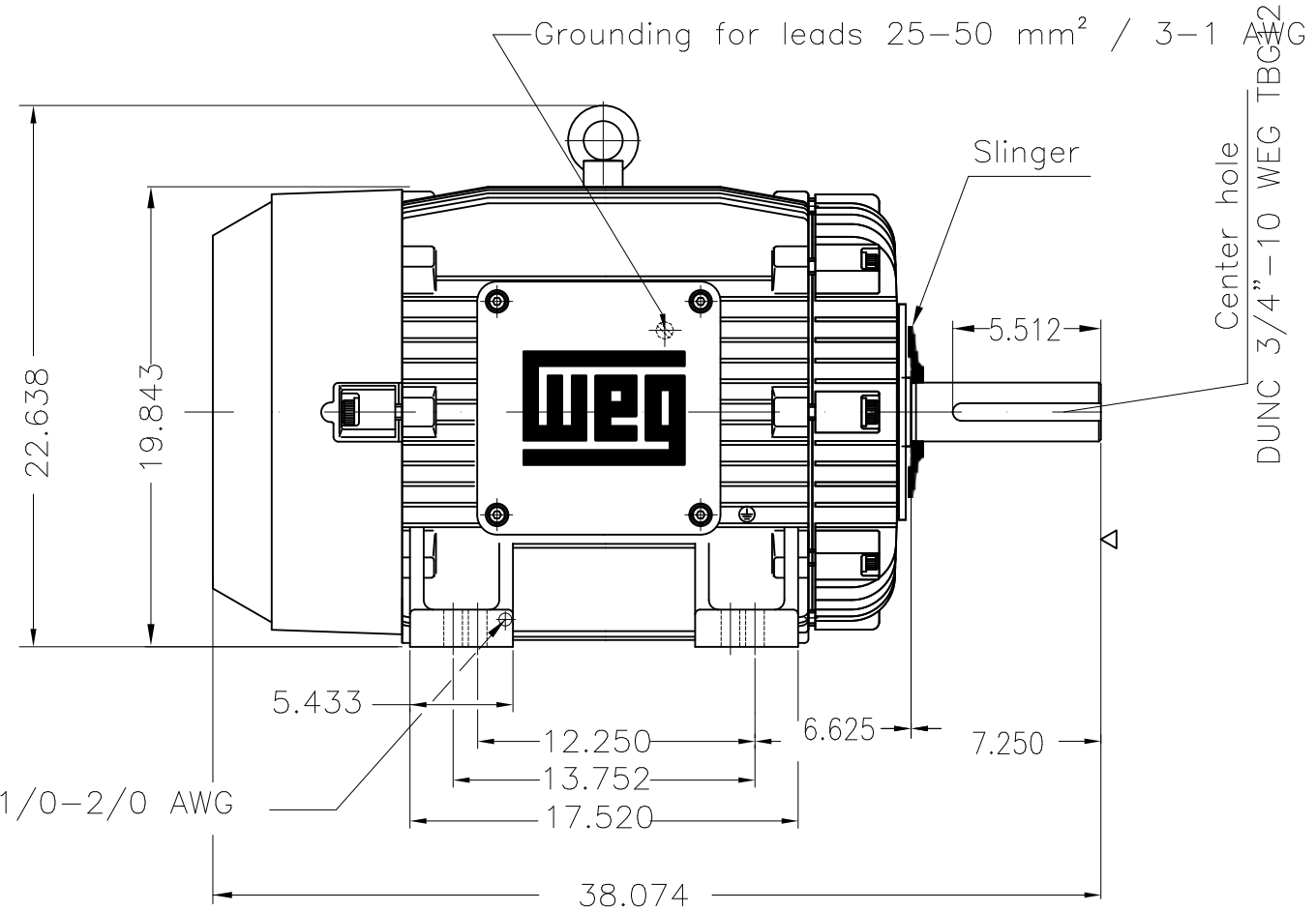

Grounding for leads 50-70 mm² / 1/0-2/0 AWG

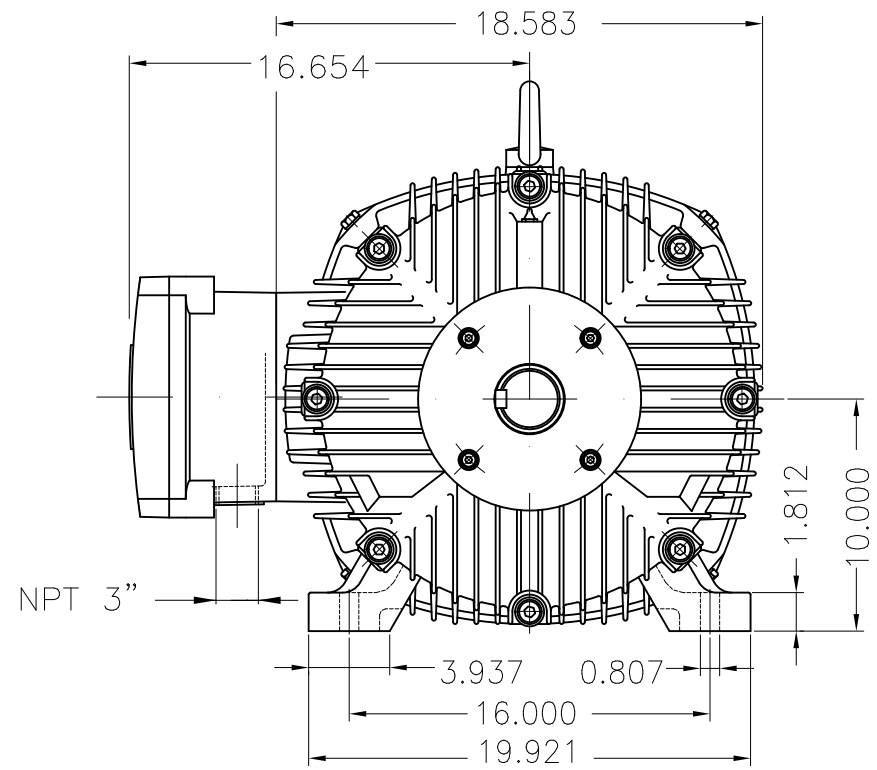
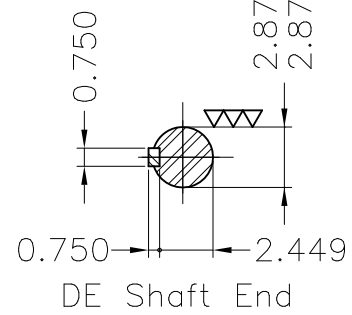

Color RAL 5009
Painting plan 202P
Mounting B3R(D)

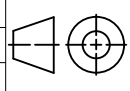
ECM	LOC	SUMMARY OF MODIFICATIONS			EXECUTED	CHECKED	RELEASED	DATE	VER
EXECUTED	USERADMIN	 THREE PHASE EXPL. PROOF MOTOR NEMA P.EFF FRAME 404/5T IP55 TEFC WEG code: 12408370							
CHECKED									
RELEASED									
REL DT	24.07.2017	WMO	Jaragua do Sul	Product Engineering	SHEET	1 / 1			

60 HP 08 Poles 60Hz

A

