

DATE
APRIL 26, 2004
CATALOG NO.
HB0012

OUTLINE DIMENSIONS
3-PHASE INDUCTION MOTOR

MOTOR TYPE:
AEHH8B
FRAME NO. 143T

Pole	HP	KW	Hz	VOLT	Syn.Speed RPM
2	1	.75	60	460	3600

Ins	Rating	Dimension in	Approx Weight	Bearings
F	CONT.	inches	46 lbs.	DE: 6205ZC35CNDE: 6205ZC35C

Totally Enclosed Fan-Cooled Type.Squirrel-Cage Rotor.

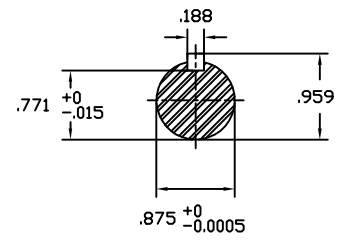
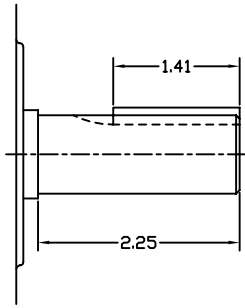
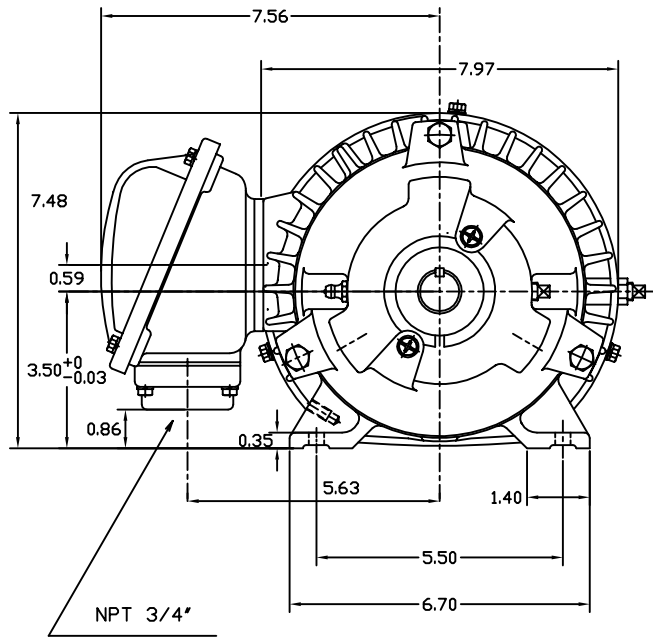
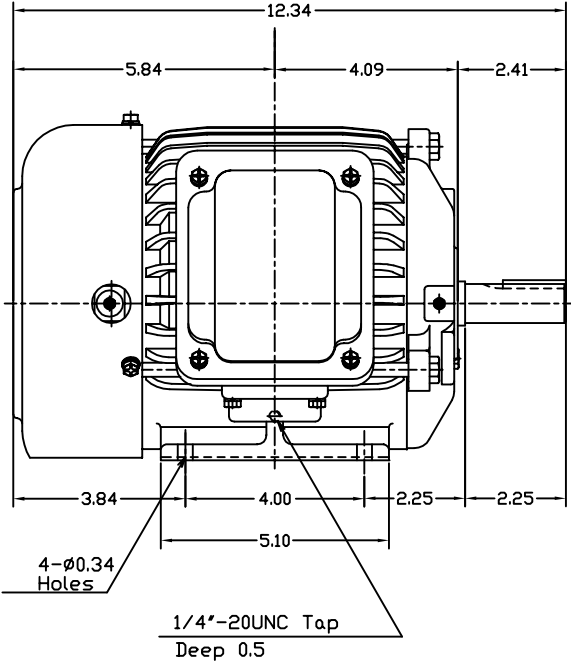

+	◇		
---	---	--	--

DWN.	胡峰誠	11 ·12 ·98
CHKD.	羅清水	11 ·23 ·98
APPD.	黃友伯	11 ·23 ·98



DWG NO.
31049HB889000