

TYPE	OUTPUT		POLE	TIME RATING	VOLTAGE V	Hz	SYN.SPEED R.P.M
	HP.	KW.					
AEHH8N	450	336	6	CONT.	460	60	1200

TOTALLY ENCLOSED FAN-COOLED TYPE, SQUIRREL-CAGE ROTOR

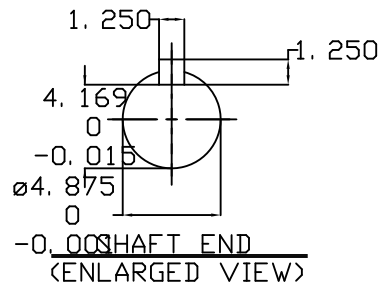
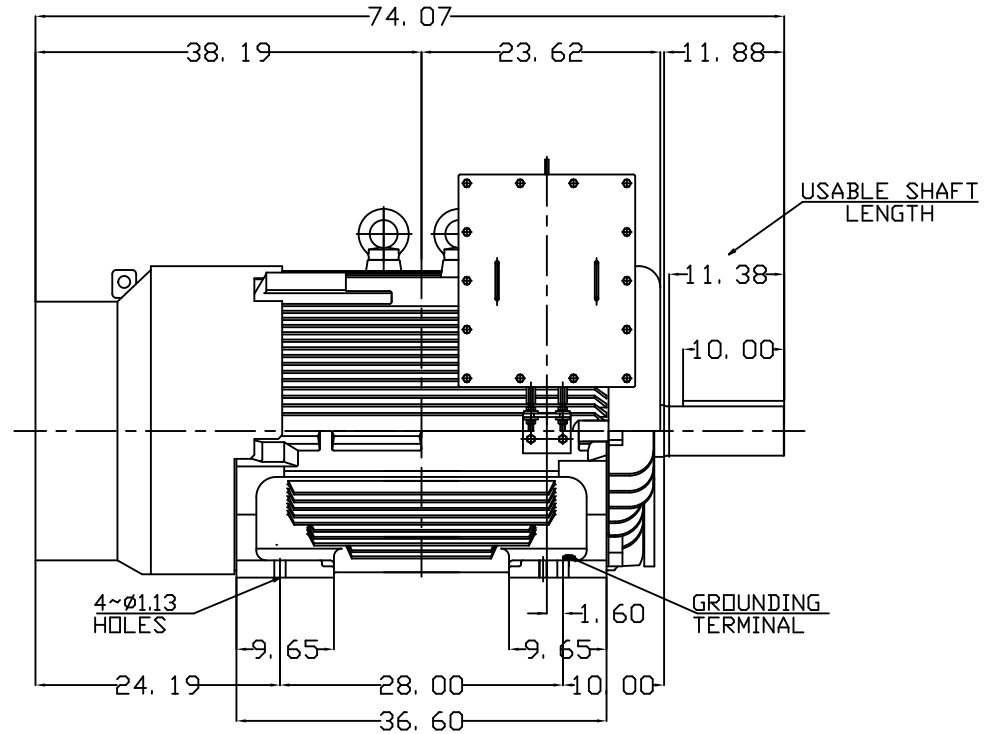
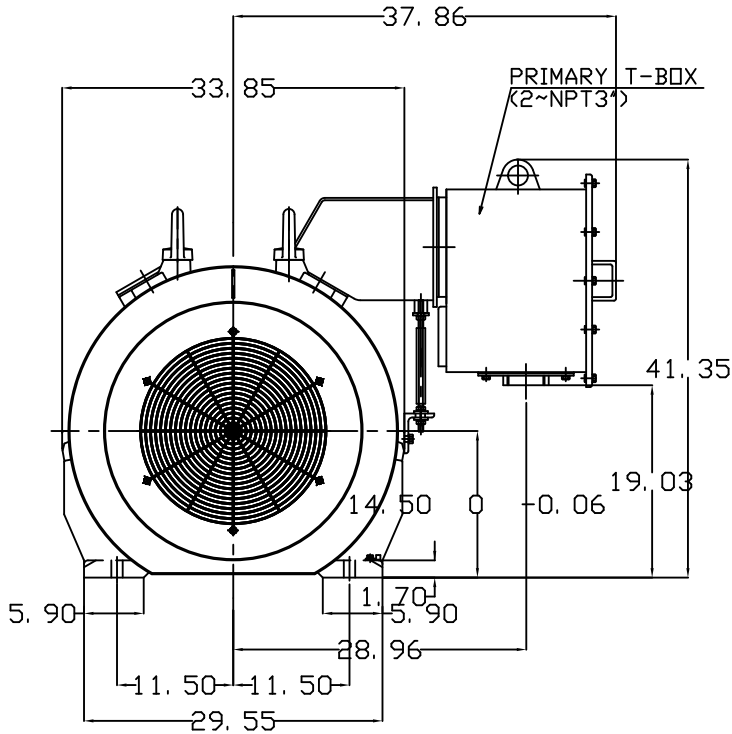

NOTE:

1. DIMENSIONS IN inch
2. FRAME NO. 5808C
3. F CLASS INSULATION, S.F.1.15
4. FOR BELT DRIVE APPLICATIONS
5. ENCLOSURE: IP55
6. BEARING SIZE: DRIVE-END NU326
OPP. DRIVE-END 6322
7. MOTOR APPROX. WEIGHT: 5250 lb

DATE	OUTLINE DIMENSIONS
CATALOG # EP4506R	3-PHASE INDUCTION MOTOR

DWN.	Y.DU	MAR-22-2014
CHKD.	W.CHENG	MAR-29-2014
APPD.	C.SHIH	MAR-29-2014

TECO Westinghouse

DWG NO. REV:00
4B040C032