

Dimensões em polegada  
Dimensions in inches

THIS IS AN UPDATED REVISION, THE  
PREVIOUS ONE MUST BE DISREGARDED.

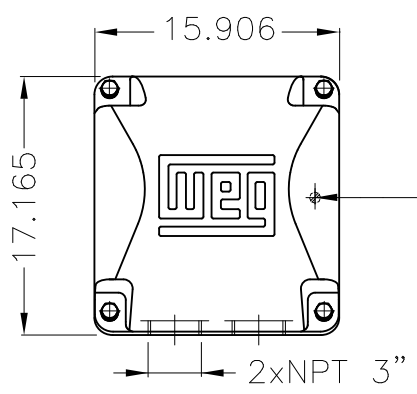
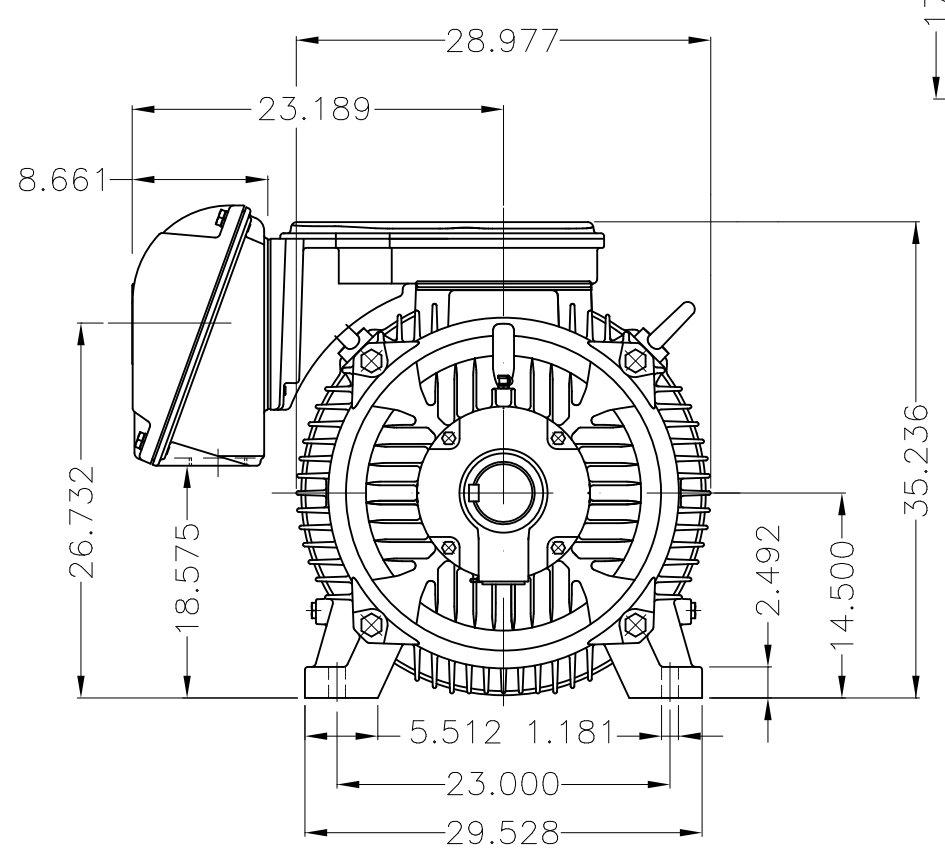

Main terminal box

Grounding for leads 35-120 mm<sup>2</sup> / 1-4/0 AWG

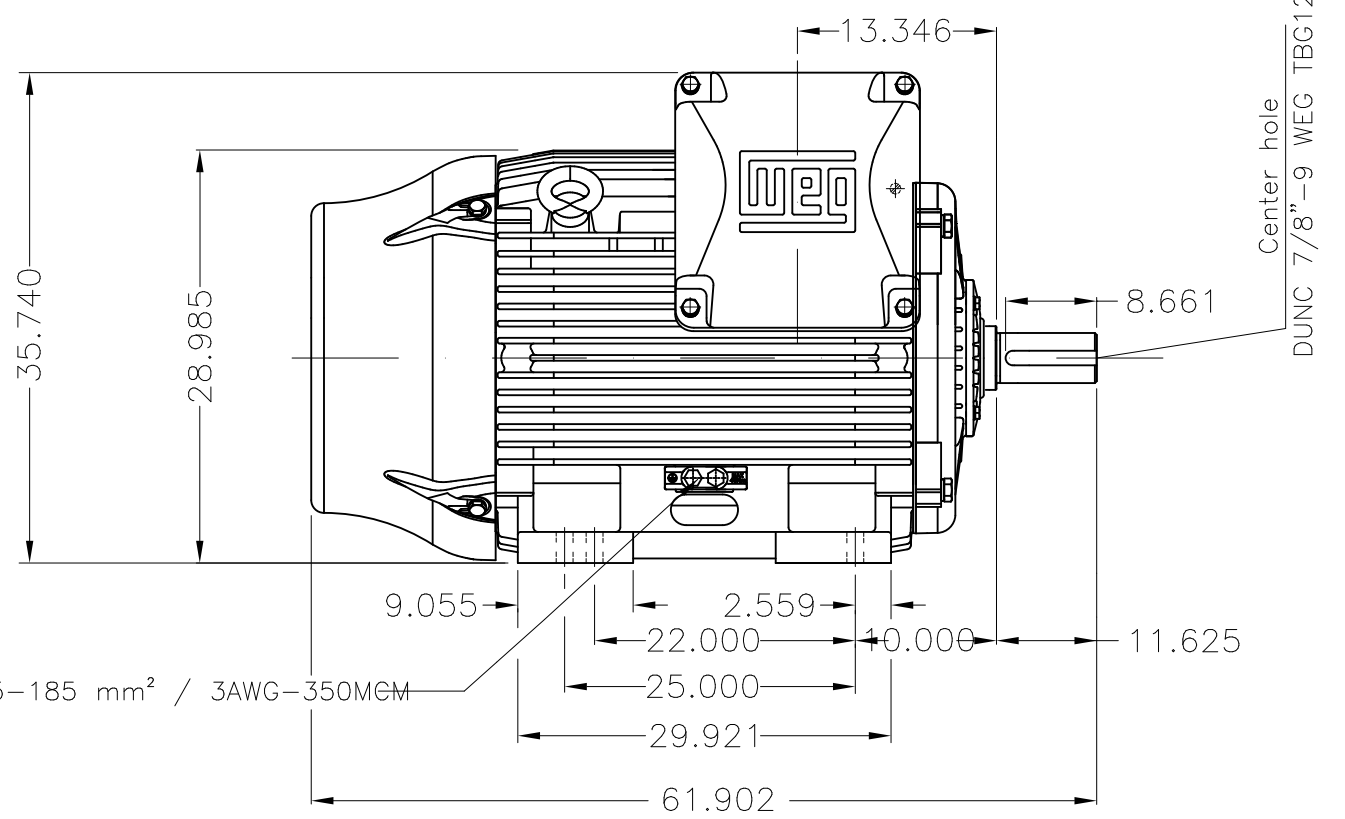

Grounding for leads 25-185 mm<sup>2</sup> / 3AWG-350MCM

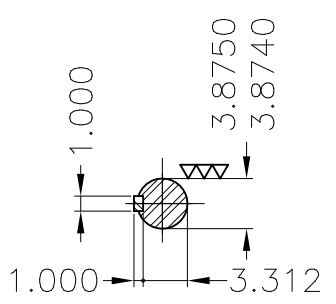

DE Shaft End

NDE endshield with electrically insulated bearing hub  
Color RAL 5009  
Painting plan 203A  
Mounting B3R(D)

ECM	LOC	SUMMARY OF MODIFICATIONS	EXECUTED	CHECKED	RELEASED	DATE	VER
EXECUTED	USERADMIN	THREE PHASE W22 MOTOR - NEMA PREMIUM EFF					
CHECKED		FRAME 586/7T IP55 TEFC					
RELEASED		WEG code: 11440692					
REL DT	24.07.2017	WMO Jaragua do Sul	Product Engineering	SHEET	1 / 1		

250 HP 06 Poles 60Hz

A

