

Dimensões em polegada
Dimensions in inches

THIS IS AN UPDATED REVISION, THE
PREVIOUS ONE MUST BE DISREGARDED.

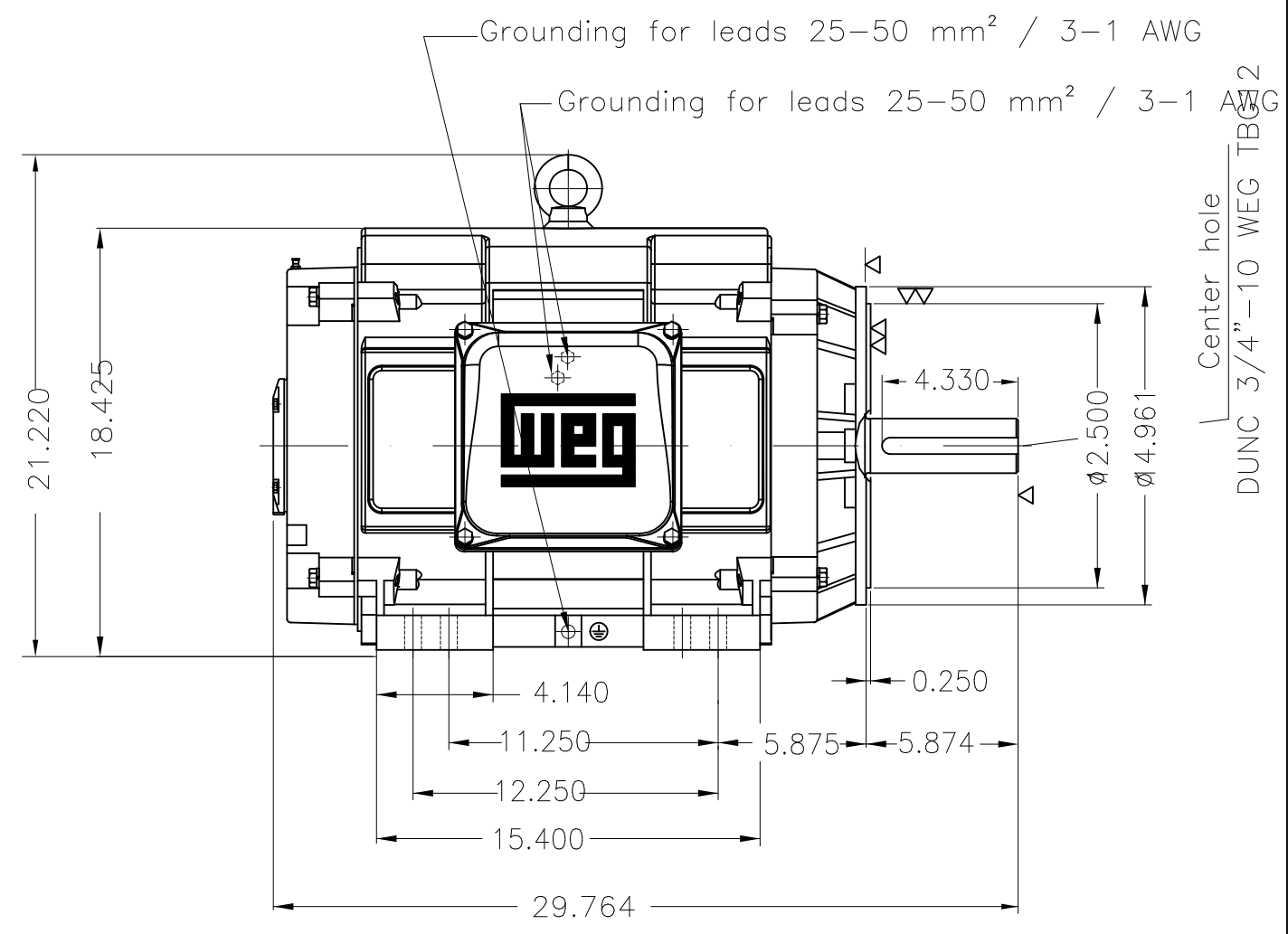
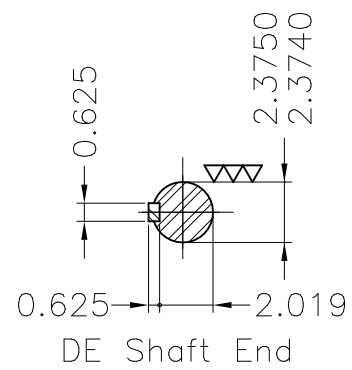
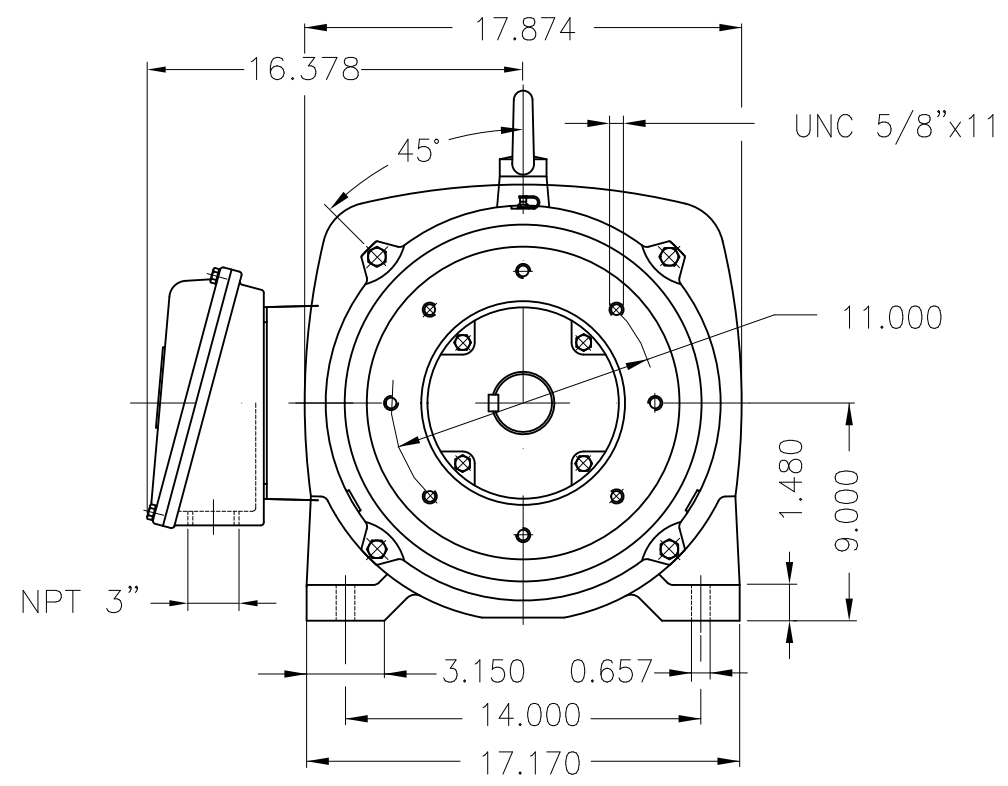

Brush holder Kit AEGIS internal DE
Color RAL 5009
Painting plan 203A
Mounting B34R(D)

ECM	LOC	SUMMARY OF MODIFICATIONS			EXECUTED	CHECKED	RELEASED	DATE	VER
EXECUTED	USERADMIN		THREE PHASE NEMA P. EFF MOTOR						
CHECKED			FRAME 364/5TC IP23 ODP						
RELEASED			WEG code: 13218222						
REL DT	24.07.2017	WMO	Jaragua do Sul	Product Engineering	SHEET	1 / 1			

60 HP 04 Poles 60Hz

A

