

DATE
JUNE 21, 2005
CATALOG NO.
EPO0145

OUTLINE DIMENSIONS
3-PHASE INDUCTION MOTOR

MOTOR TYPE:
AEHH8N
FRAME NO. 143T

Pole	HP	KW	Hz	VOLT	Syn. Speed RPM
4	1	.75	60	575	1800

Ins	Rating	Dimension in	Approx Weight	Bearings
F	CONT.	inch	55 lbs.	DE: 6205ZZ NDE: 6205ZZ

Totally Enclosed Fan-Cooled Type. Squirrel-Cage Rotor.

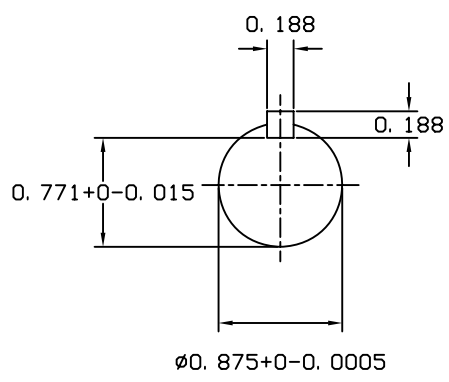
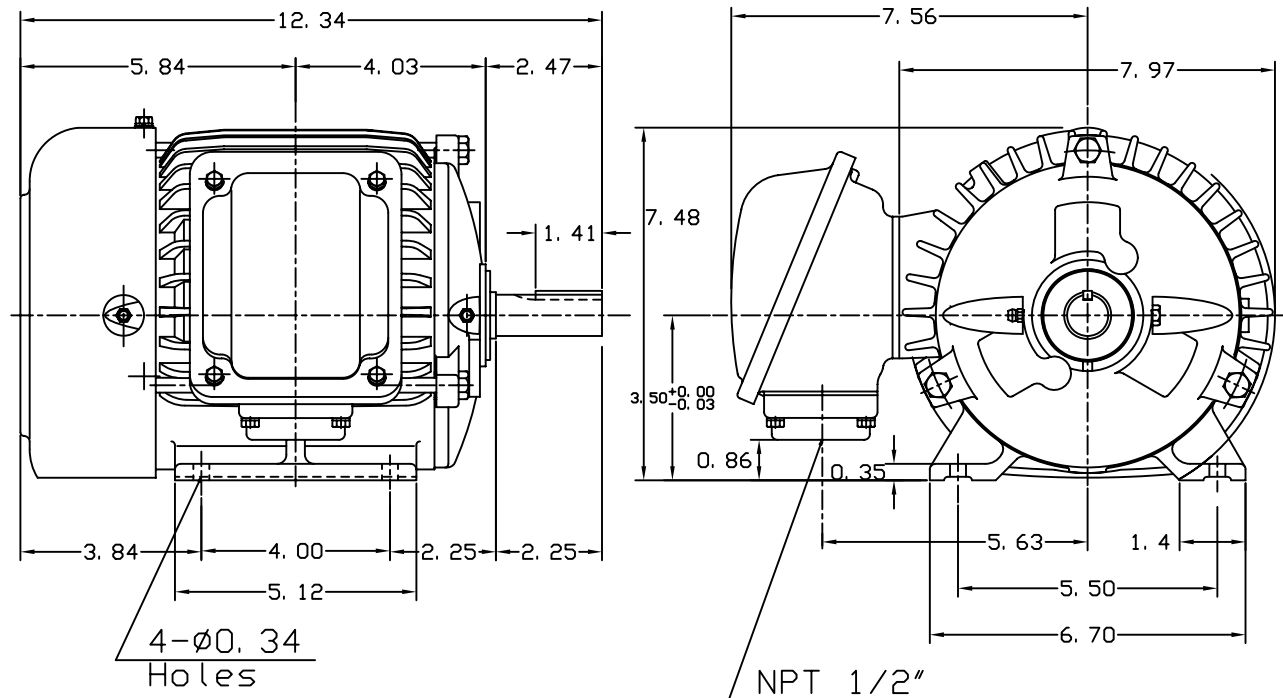

◇		
---	--	--

DWN.	J. H. LIANG	11-30-98
CHKD.	C. S. LO	12-29-98
APPD.	Y. B. HUANG	12-29-98



DWG NO.
31057H351000