

THIS IS AN UPDATED REVISION, THE PREVIOUS ONE MUST BE DISREGARDED.

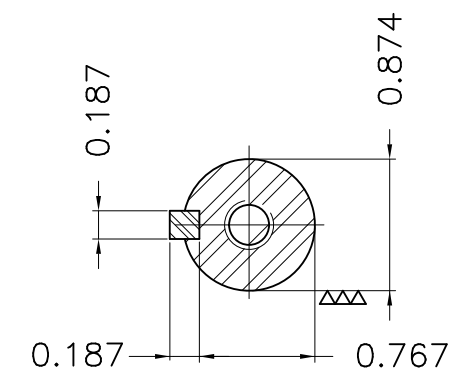

Mounting B34R(D)									
ECM	LOC	SUMMARY OF MODIFICATIONS			EXECUTED	CHECKED	RELEASED	DATE	VER
EXECUTED	USERADMIN		SINGLE PHASE MOTOR JM						
CHECKED			FRAME 215JM IP55 TEFC						
RELEASED			WEG code: 10371759						
REL DT	24.07.2017	WMO	Jaragua do Sul	Product Engineering	SHEET	1 / 1			

7.5 HP 04 Poles 60Hz

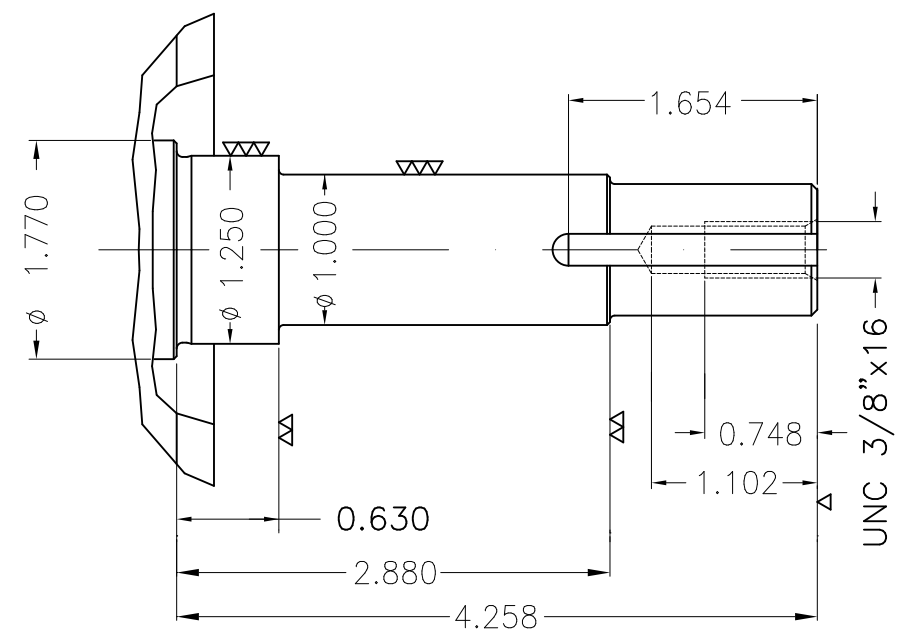
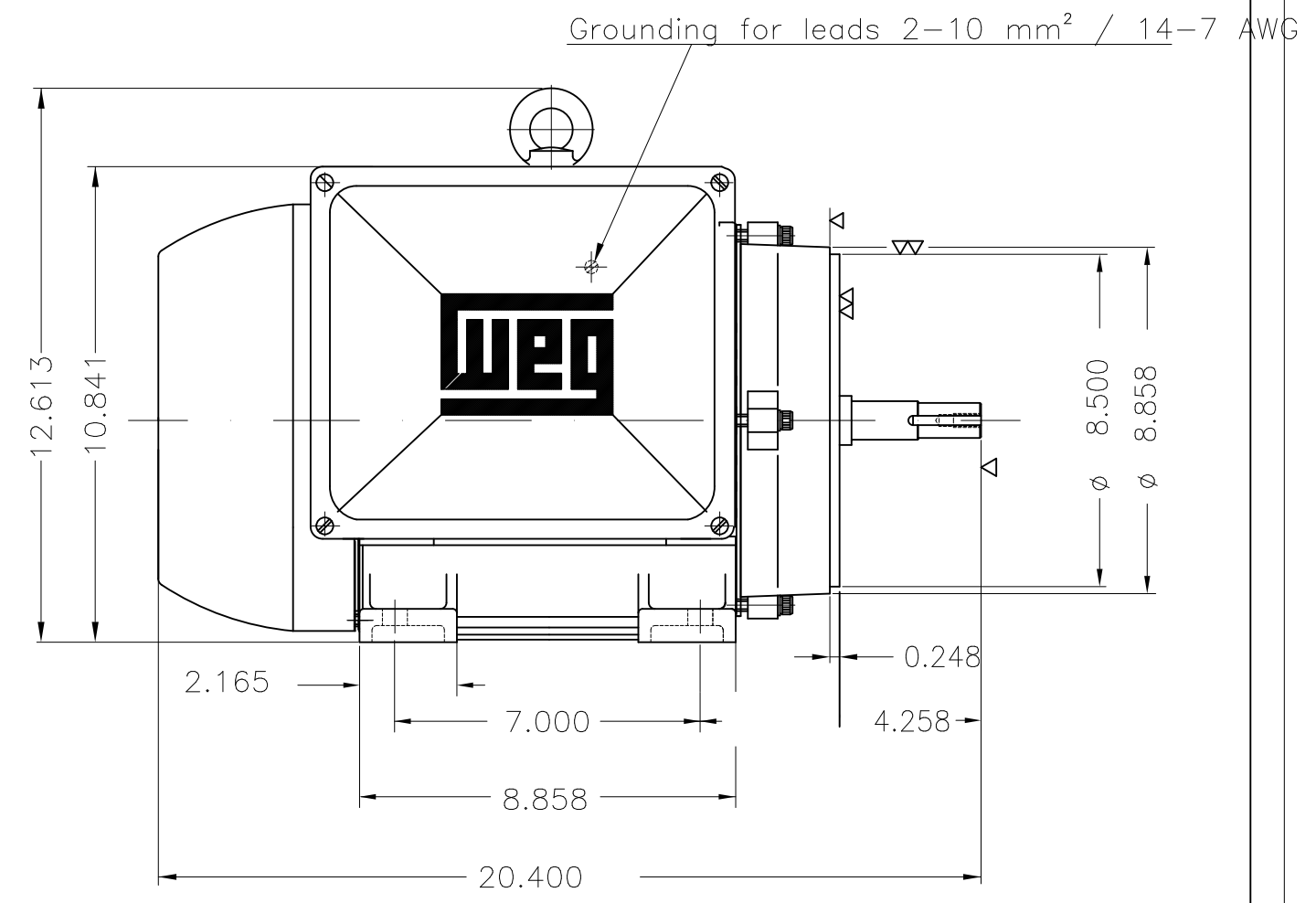
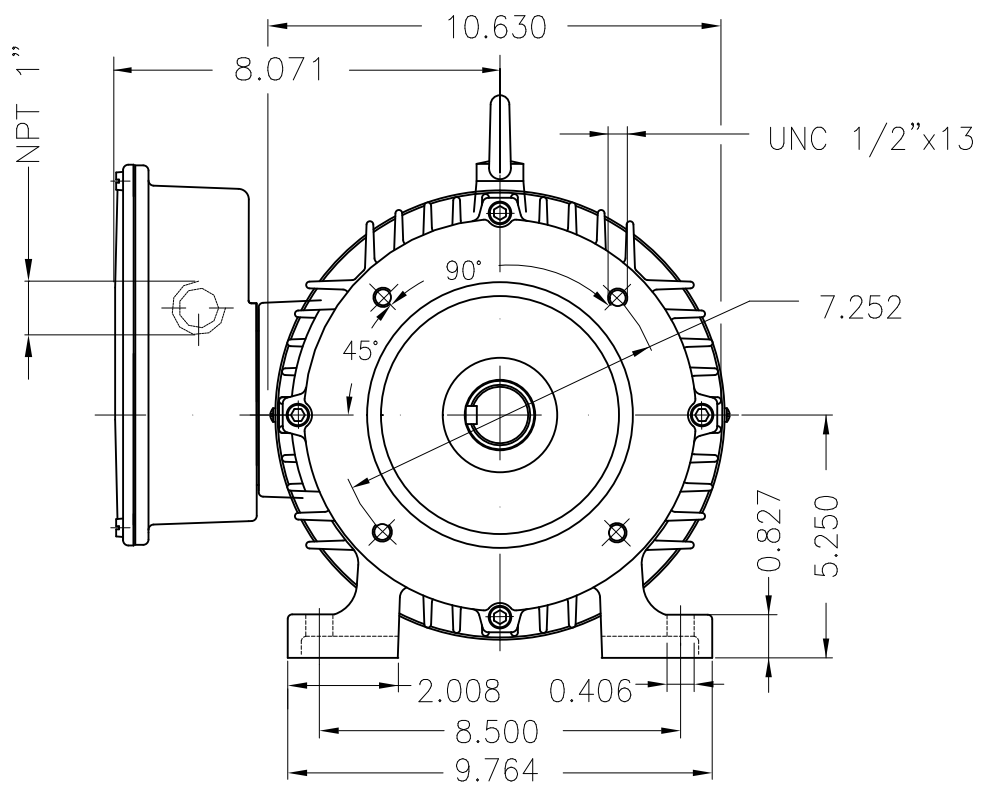
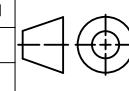