

DATE
JAN. 4, 2007
CAT. #: EPV0204C

OUTLINE DIMENSIONS
3-PHASE INDDUCTION MOTOR

MOTOR TYPE:
AEUH8NDC
FRAME NO. 256TC

Pole	HP	kW	Hz	VOLT	Syn. Speed r/min(rpm)
4	20	15	60	230/460	1800

Ins	Rating	Dimension in	Approx Weight	Bearings
F	CONT.	inches	355 LBS	DE: 6309ZZ NDE: 6307ZZ

Totally Enclosed Fan-Cooled Vertical Type, Squirrel-Cage Rotor.

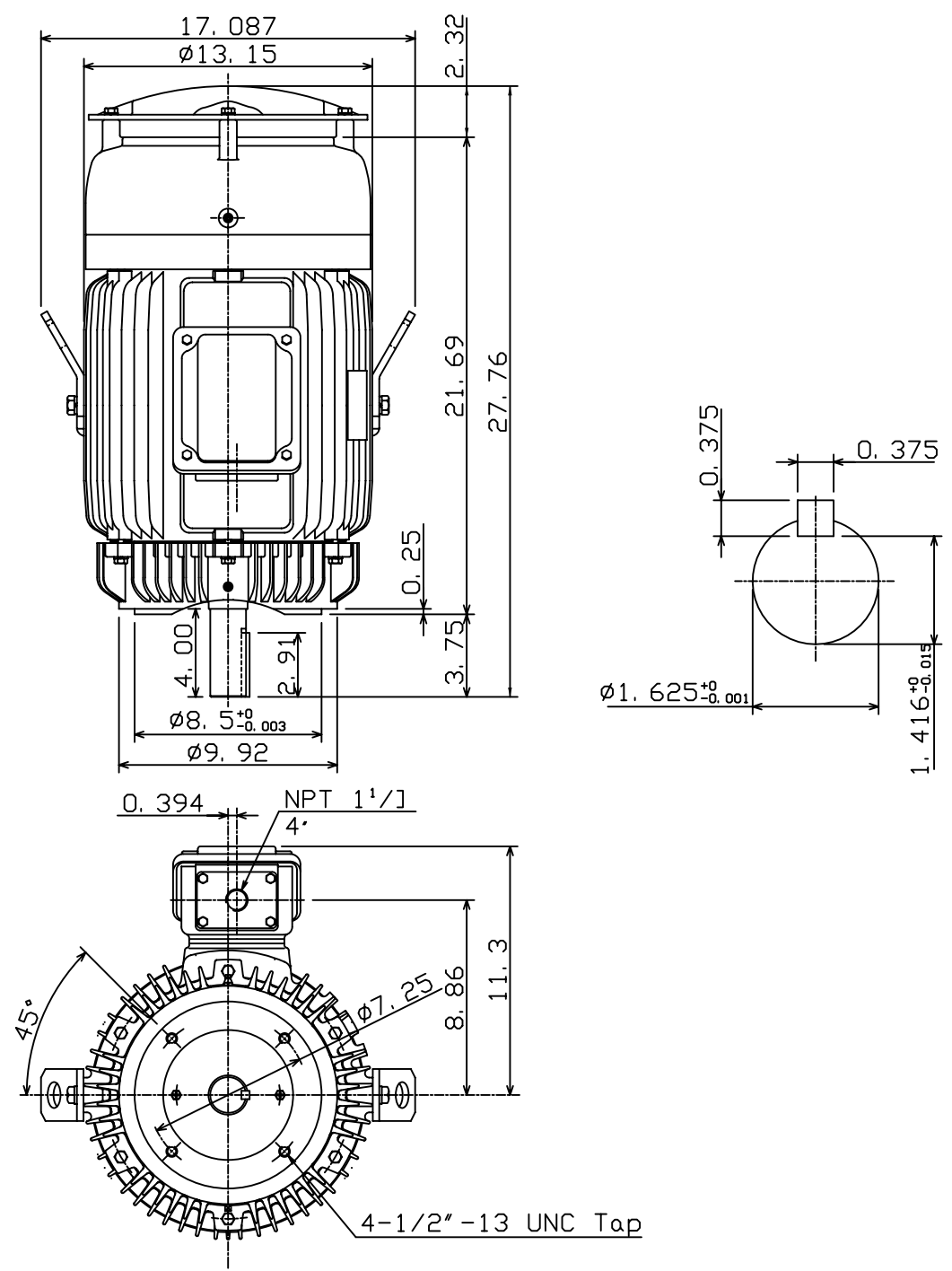

\diamond		
------------	--	--

DWN.	K. L. KUD	12-30-06
CHKD.	K. L. KUD	01-02-07
APPD.	M. C. TSAI	01-02-07



DWG NO.
31057H251490