

Dimensões em mm
Dimensions in mm

THIS IS AN UPDATED REVISION, THE
PREVIOUS ONE MUST BE DISREGARDED.

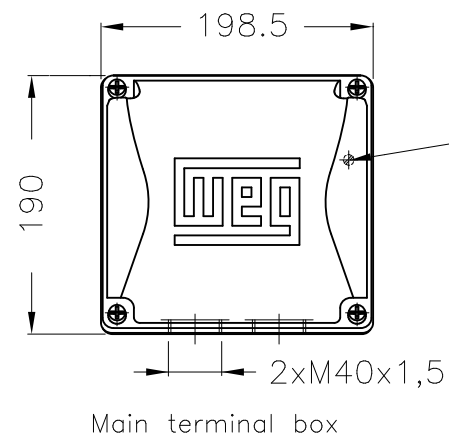

Grounding for leads 5.2–25 mm² / 10–4 AWG

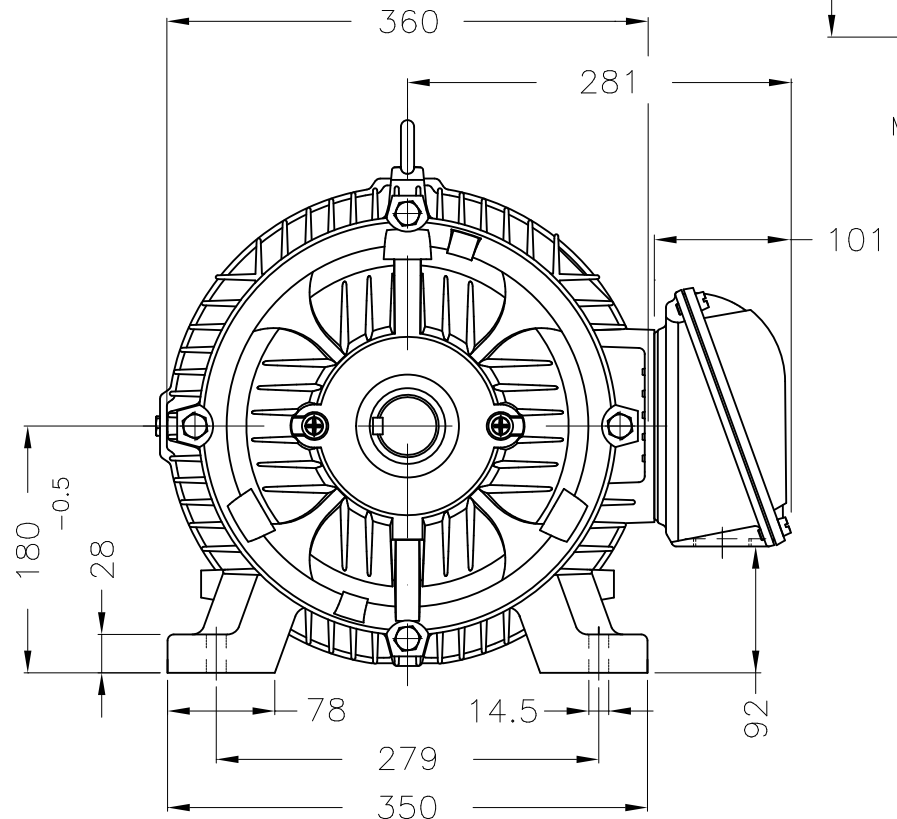
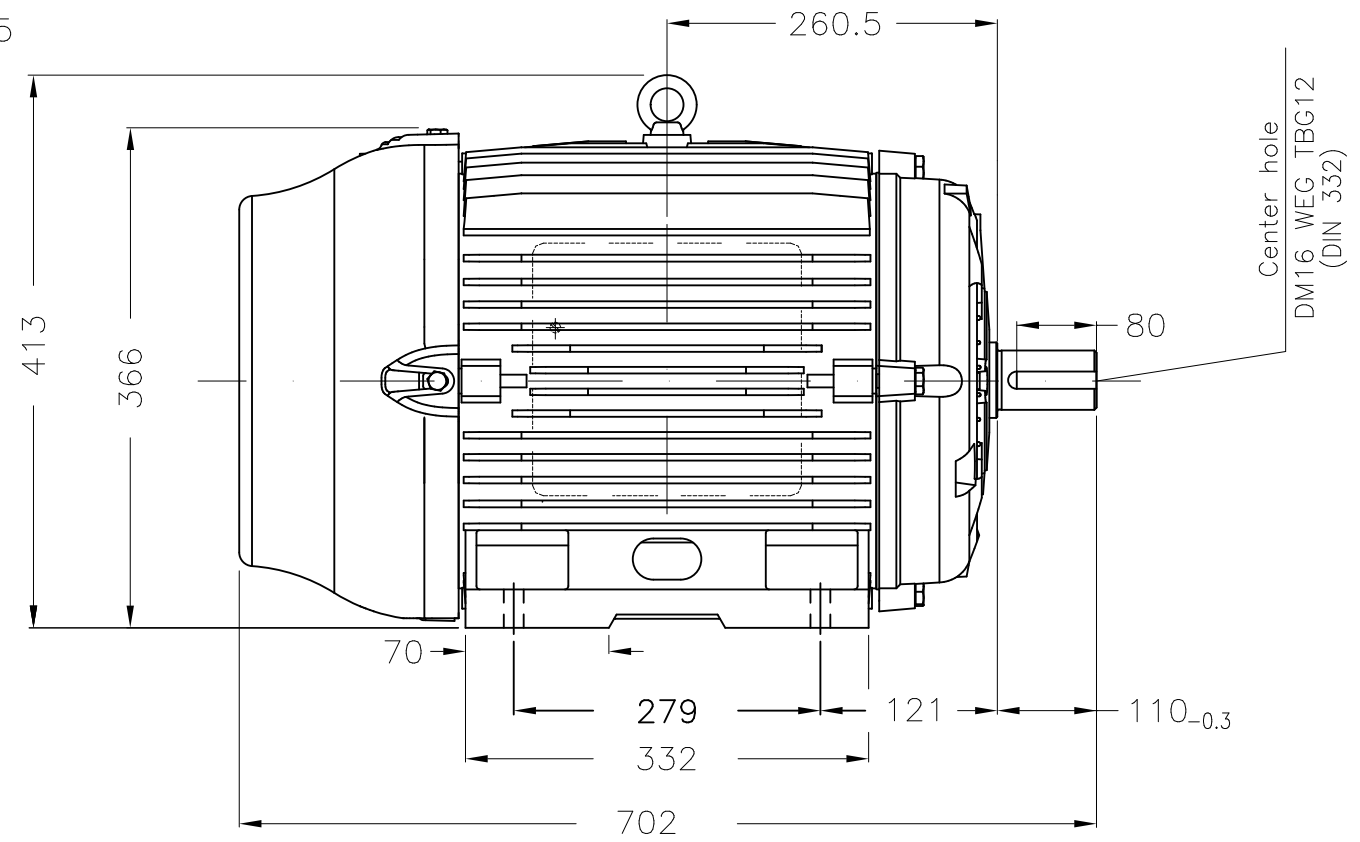

Center hole
DM16 WEG TBG12
(DIN 332)

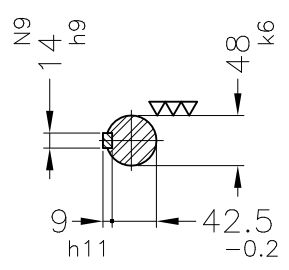

DE Shaft End

Color RAL 5009
Painting plan 203A
Mounting B3L(E)

ECM	LOC	SUMMARY OF MODIFICATIONS			EXECUTED	CHECKED	RELEASED	DATE	VER
EXECUTED	USERADMIN		THREE PHASE W22 TRU-METRIC PREMIUM EFF						
CHECKED			FRAME 180L IP55 TEFC						
RELEASED			WEG code: 11567472						
REL DT	24.07.2017	WMO	Jaragua do Sul	Product Engineering	SHEET	1 / 1			

30 HP 04 Poles 60Hz

A

