

DATE
DEC. 13, 2010
CAT. #: NP0406

OUTLINE DIMENSIONS
3-PHASE INDUCTION MOTOR

MOTOR TYPE:
AEHH8P
FRAME NO. 364T

Pole	HP	kW	Hz	VOLT	Syn.Speed r/min(rpm)
6	40	29.8	60	230/460	1200

Ins	Rating	Dimension in	Approx Weight	Bearings	
F	CONT.	inch	779 lbs.	DE: 6313	NDE: 6213

Totally Enclosed Fan-Cooled Type. Squirrel-Cage Rotor.

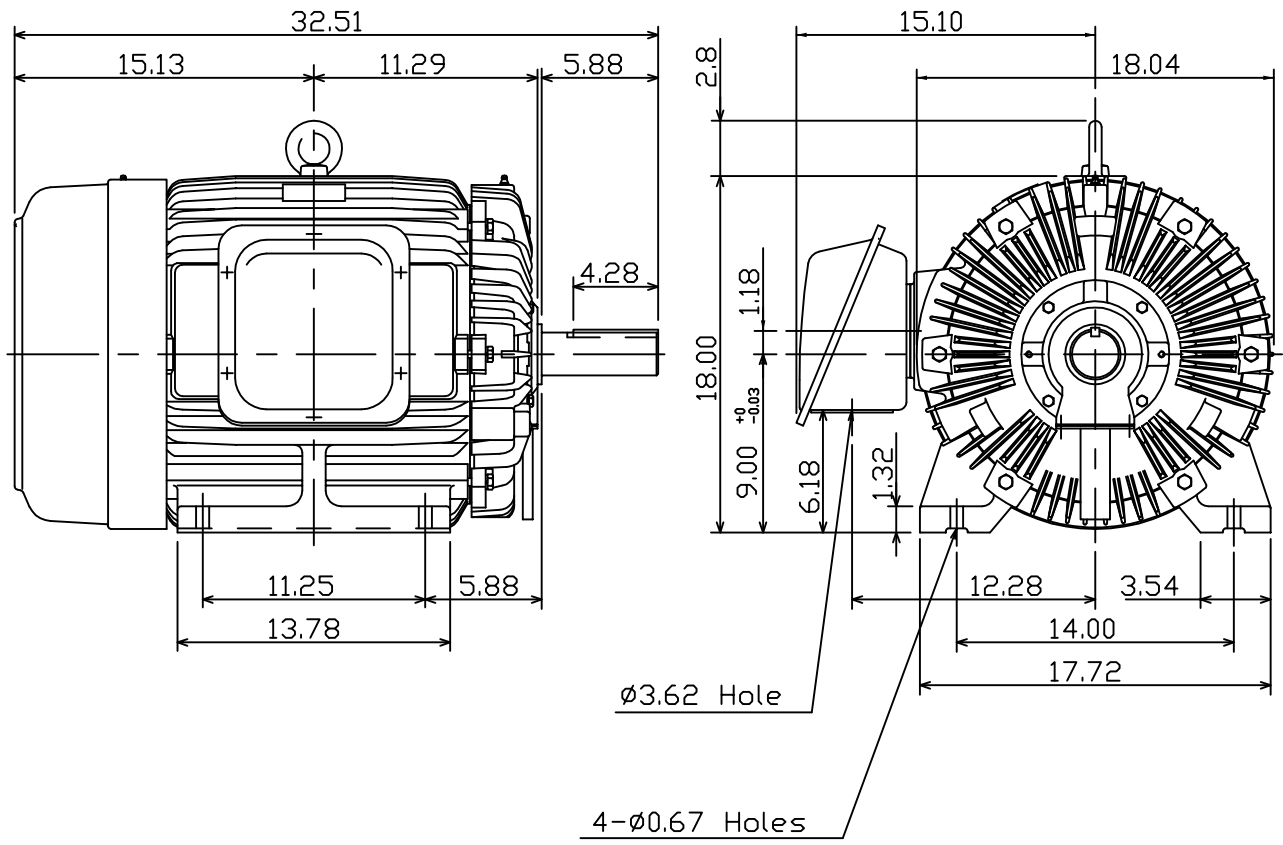

12.06.10 郭耿良

DWN, J.H.LIANG	05 :20 99
CHKD, C.H.KAD	06 :15 99
APPD, Y.B.HUANG	06 :15 99



DWG NO.
31049M055082