

Dimensional Drawing

Catalogue	Model	HP	Pole	kW	Rating	Voltage	Hz	RPM
CJP01025	AEHH8N JP	10	2	7.5	Continuous	575 V	60	3600

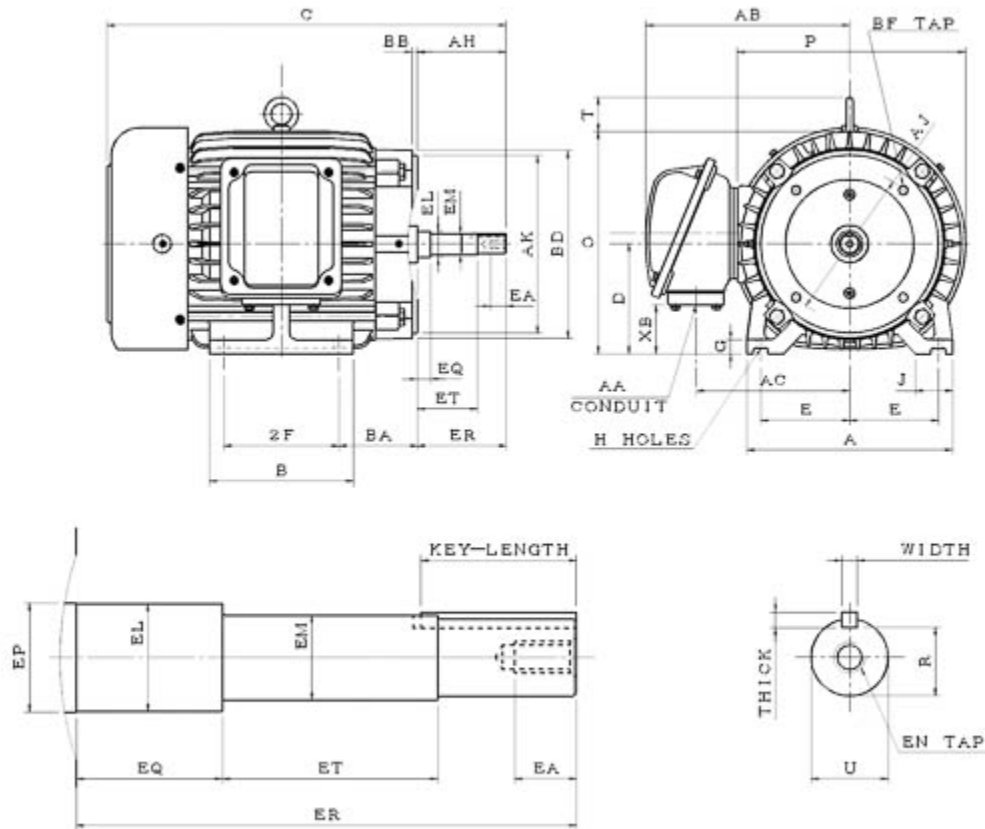

AEHH8N-JP-SMP-3

Frame Size	Mounting					A	B	C	CD	D	
	E	2F	2F2	H	BA						
215JP	4.25	7		0.41	3.75	9.85	8.35	24.745		5.25	
G	J	K	L	M	O	P	T	Key			Keyseat
0.7	1.75				10.63	11.1	1.65	Width	Thick	Length	R
								0.25	0.25	2.53	1.112
Terminal Housing			Aux Box			C/D Flange					
AA	AB	AC	XB	AE	AX	BB	AH	AK	BD	AJ	BF
1"	9.78	7.34	2.34			0.25	8.125	8.5	8.98	7.25	4-1/2"13UNC
Shaft Extension			Bearings		Approx. Weight Lbs	SPL dBA/3ft	Ins. Class	S.F.	Drive Method	Dimensions	
N-W	U	V	DE	NDE							
	1.25		6308ZZ	6306ZZ	185	71	F	1.15	DirectCoupling	Inches	

Technical Data Sheet

Motor Type: AEHH8N_JP

Catalogue No: CJP01025

Nameplate Information

HP	Pole	RPM	Frame	Voltage	Hz	Phase
10	2	3510	215JP	575	60	3
Enclosure	Ins. Class	Service Factor	Time Rating	NEMA Design	Rated Amb.	Rated Altitude
TEFC	F	1.15	Continuous	B	-40 to 40 °C	<3300 ft

Typical Performance

Efficiency (%)				Power Factor (%)		
Full Load		3/4 Load	1/2 Load	Full Load	3/4 Load	1/2 Load
Nom.	Min.					
91.0	89.5	91.7	91.0	89.5	88.5	82.5
Torque				Current (A)		
Full Load (lb-ft)	Locked Rotor (% FLT)	Pull Up (% FLT)	Break Down (% FLT)	No Load	Full Load	Locked Rotor
14.96	220	180	260	2.4	9.2	65
NEMA KVA Code	Inertia (WR ²)			Safe Stall Time (s)		Noise Level Sound Press. dB(A)
	Rotor (lb-ft ²)	NEMA Load (lb-ft ²)	Max. Allowable (lb-ft ²)	Cold	Hot	
H	0.573	11	20	17	12	71

VFD Duty Information

Speed Range			VFD		S.F.
Constant Torque	Variable Torque	Constant Power	Carrier	Type	
6-60Hz	3-60Hz	60-90Hz	≤ 5 kHz	VPWM or CPWM	1.0 Only

Additional Information

Bearings		Approx. Weight
DE	NDE	lbs
6308ZZ	6306ZZ	185

Hazardous Locations Information

CSA Certified	
Class I, Div 2, Groups B, C & D	
Class I, Zone 2, Groups IIB+H2, IIB & IIA	
Temp Code (Sinewave / VFD)	T3C / T3B