

Dimensões em polegada  
Dimensions in inches

THIS IS AN UPDATED REVISION, THE  
PREVIOUS ONE MUST BE DISREGARDED.

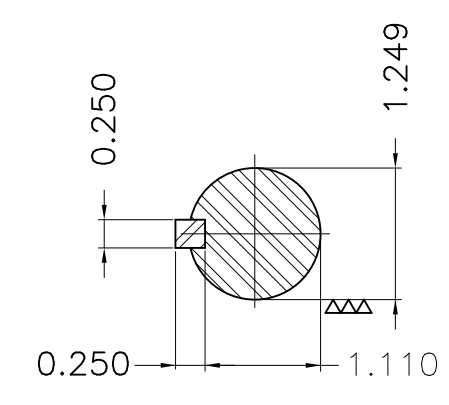
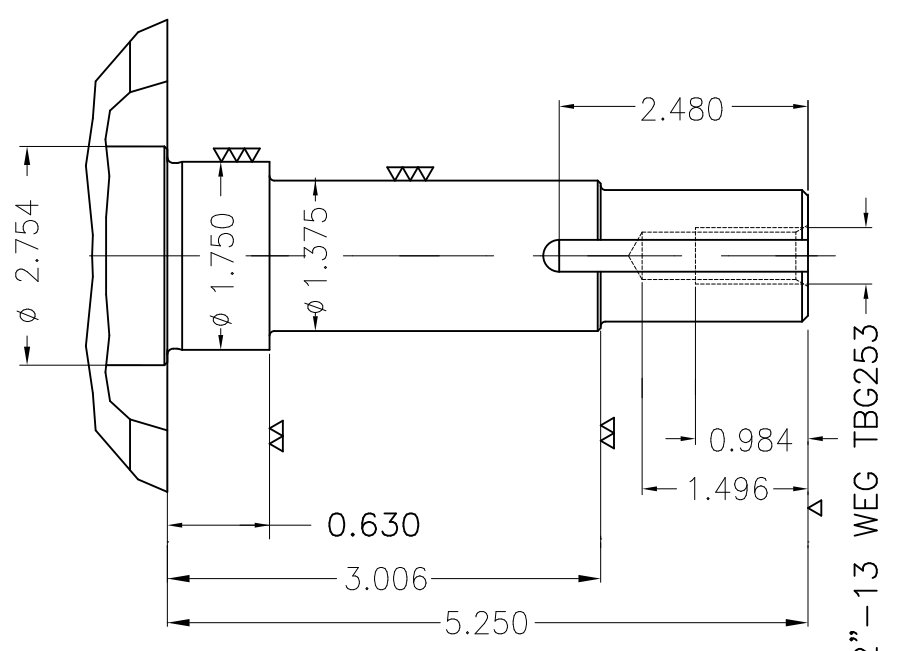
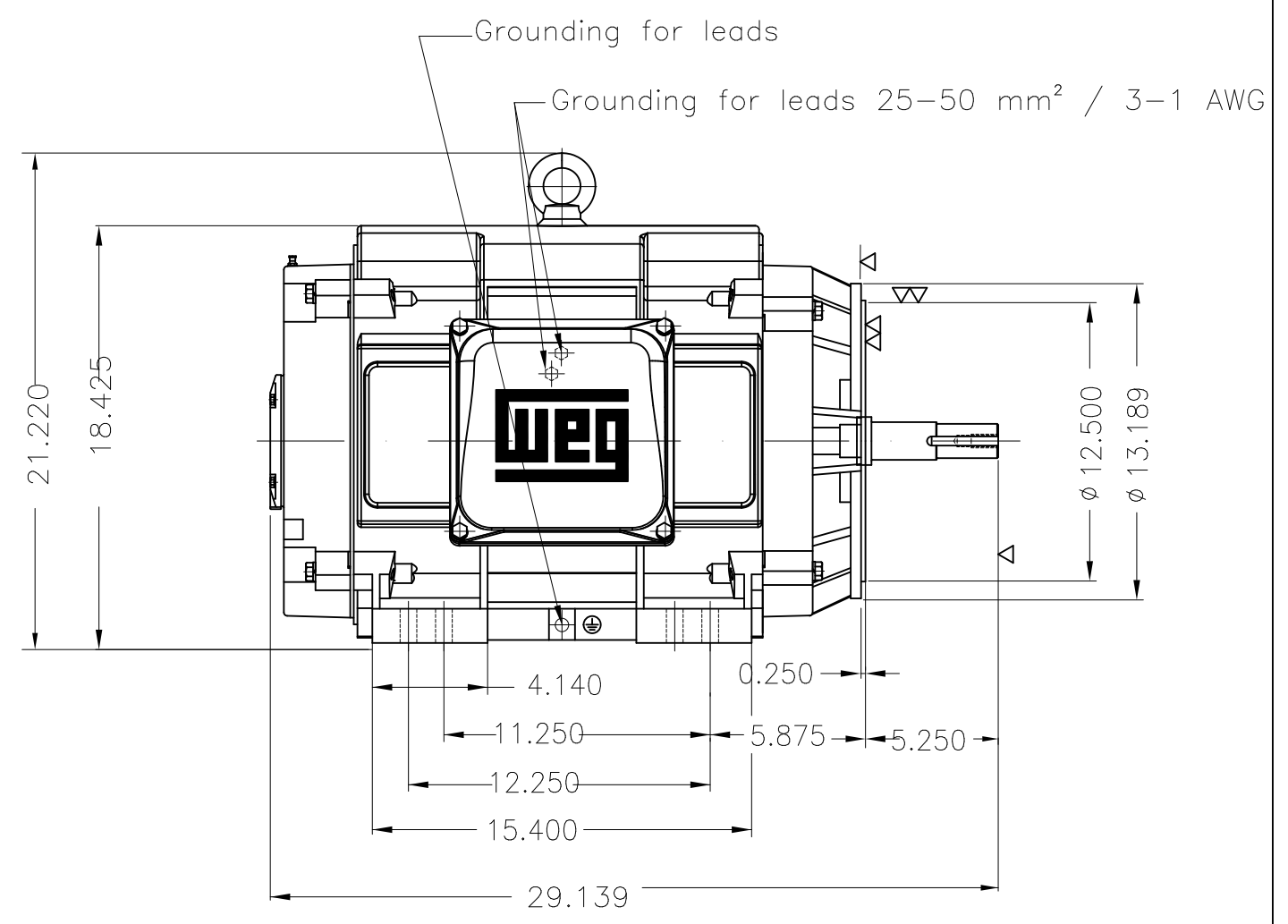
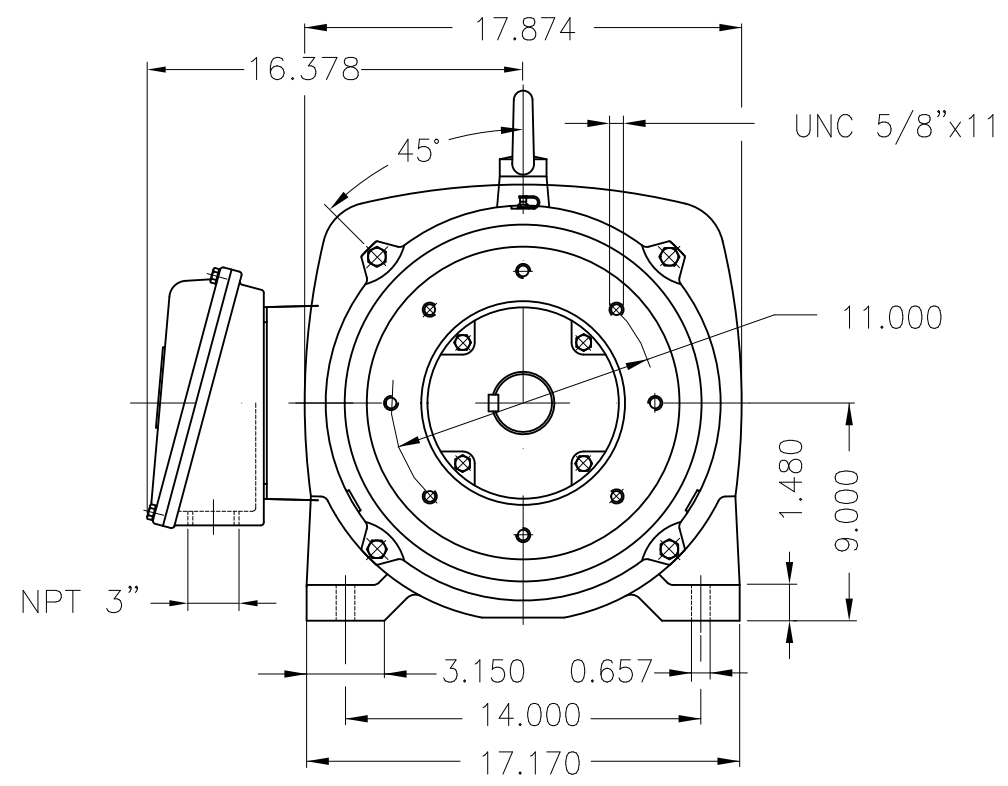

EUNC 1/2"-13 WEG TBG253

Color RAL 5009  
Painting plan 203A  
Mounting B34R(D)

ECM	LOC	SUMMARY OF MODIFICATIONS	EXECUTED	CHECKED	RELEASED	DATE	VER
EXECUTED	USERADMIN	THREE PHASE PREMIUM EFFICIENCY					
CHECKED		FRAME 364/5JM IP23 ODP					
RELEASED		WEG code: 11261503					
REL DT	24.07.2017	WMO Jaraguá do Sul	Product Engineering	SHEET	1 / 1		

60 HP 04 Poles 60Hz

