

Dimensões em polegada  
Dimensions in inches

THIS IS AN UPDATED REVISION, THE  
PREVIOUS ONE MUST BE DISREGARDED.

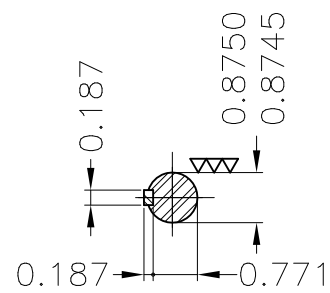

Main terminal box

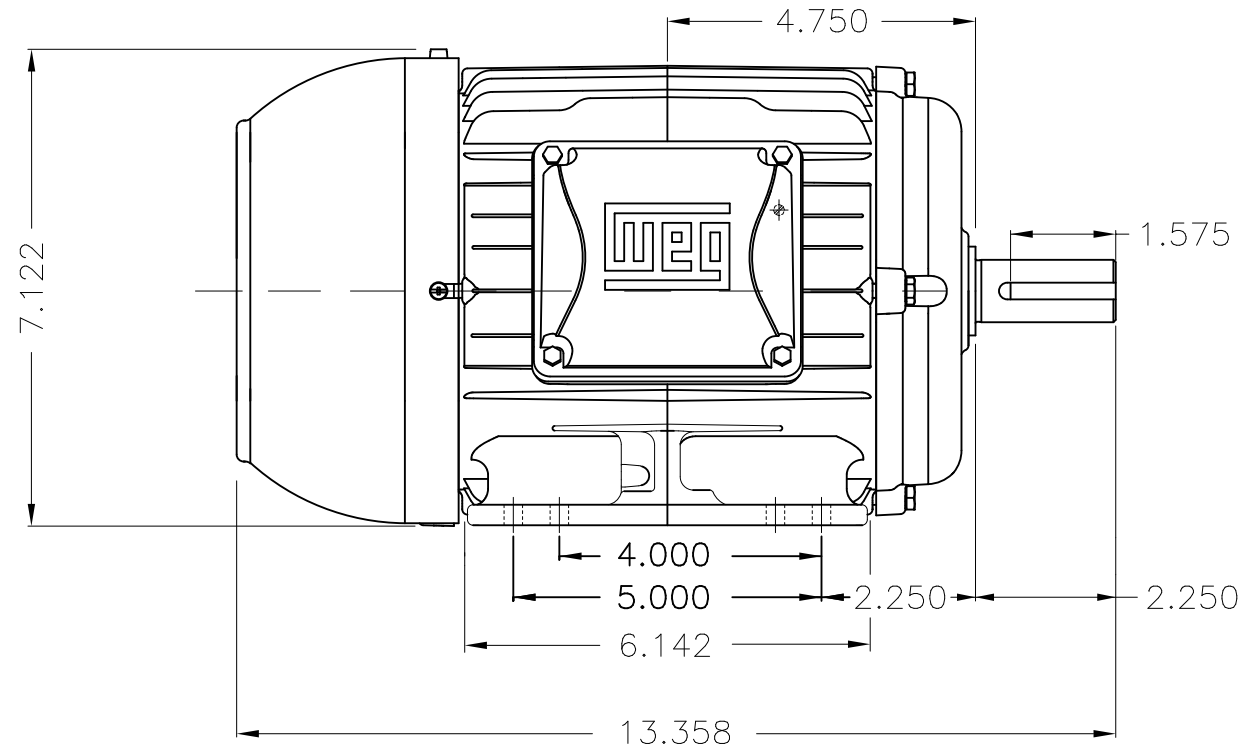
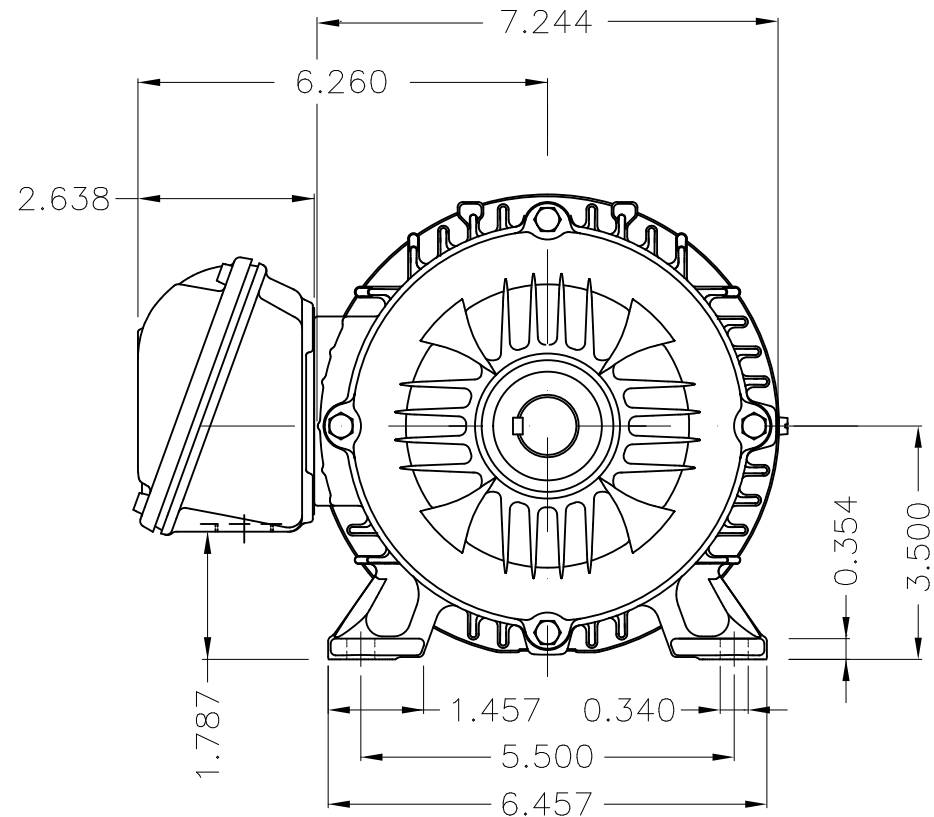

DE Shaft End

Color RAL 5009  
Painting plan 207A  
Mounting B3R(D)

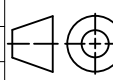
ECM	LOC	SUMMARY OF MODIFICATIONS			EXECUTED	CHECKED	RELEASED	DATE	VER
EXECUTED	USERADMIN	 THREE PHASE W22 MOTOR - NEMA PREMIUM EFF FRAME 143/5T IP55 TEFC WEG code: 12378663							
CHECKED									
RELEASED									
REL DT	24.07.2017		WMO	Jaragua do Sul	Product Engineering	SHEET	1 / 1		

1 HP 02 Poles 60Hz

