

Dimensões em polegada
Dimensions in inches

THIS IS AN UPDATED REVISION, THE
PREVIOUS ONE MUST BE DISREGARDED.



Grounding for leads 25-50 mm² / 3-1 AWG

Main terminal box

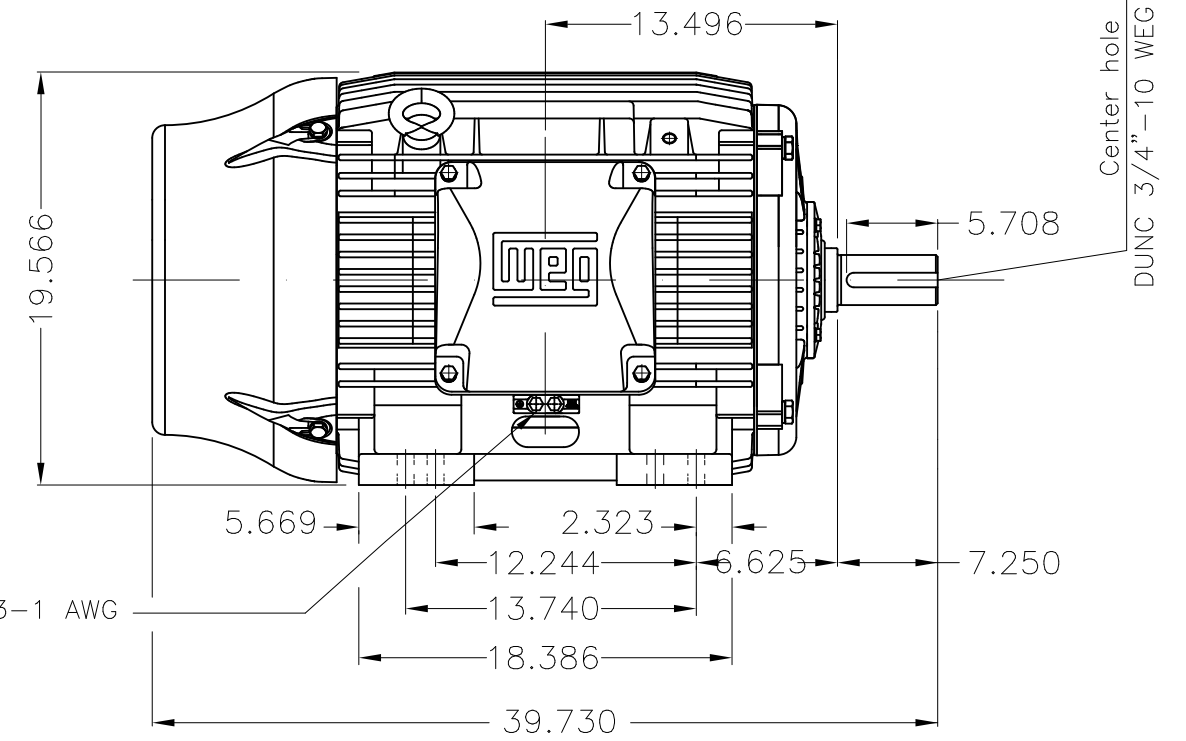
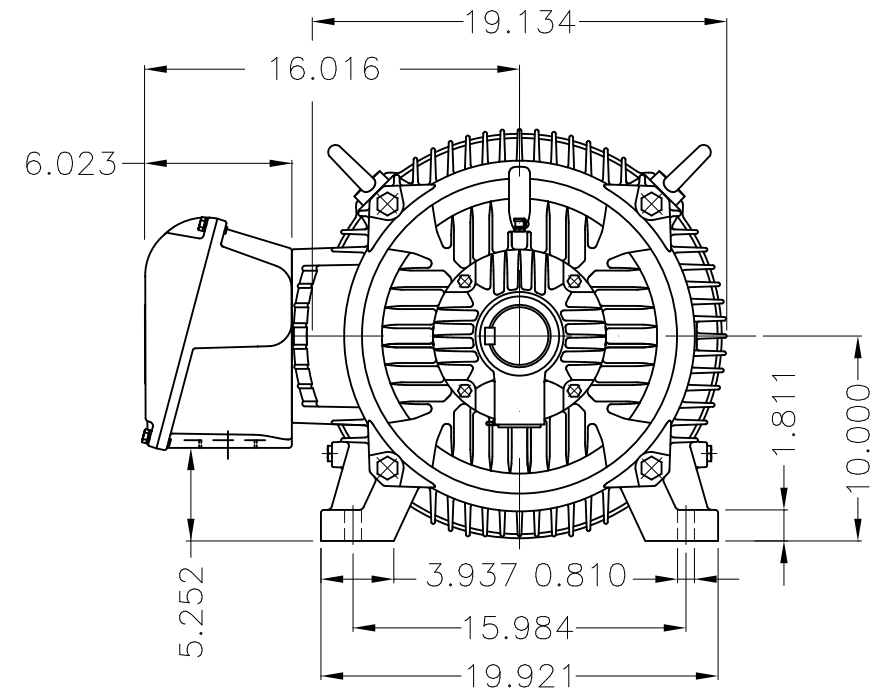

Center hole
DUNC 3/4"-10 WEG TBG12

Grounding for leads 25-50 mm² / 3-1 AWG

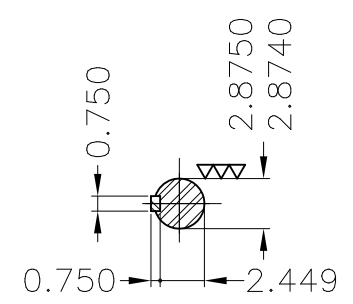

DE Shaft End

Color RAL 5009
Painting plan 202E
Mounting B3R(D)

ECM	LOC	SUMMARY OF MODIFICATIONS	EXECUTED	CHECKED	RELEASED	DATE	VER
EXECUTED	USERADMIN	THREE PH. W22 NEMA P.EFF MOTOR IEEE841					
CHECKED		FRAME 404/5T IP55 TEFC					
RELEASED		WEG code: 11431307					
REL DT	24.07.2017	WMO Jaragua do Sul	Product Engineering	SHEET	1 / 1		

75 HP 06 Poles 60Hz

A



ZME A3