

Dimensões em polegada  
Dimensions in inches

THIS IS AN UPDATED REVISION, THE  
PREVIOUS ONE MUST BE DISREGARDED.

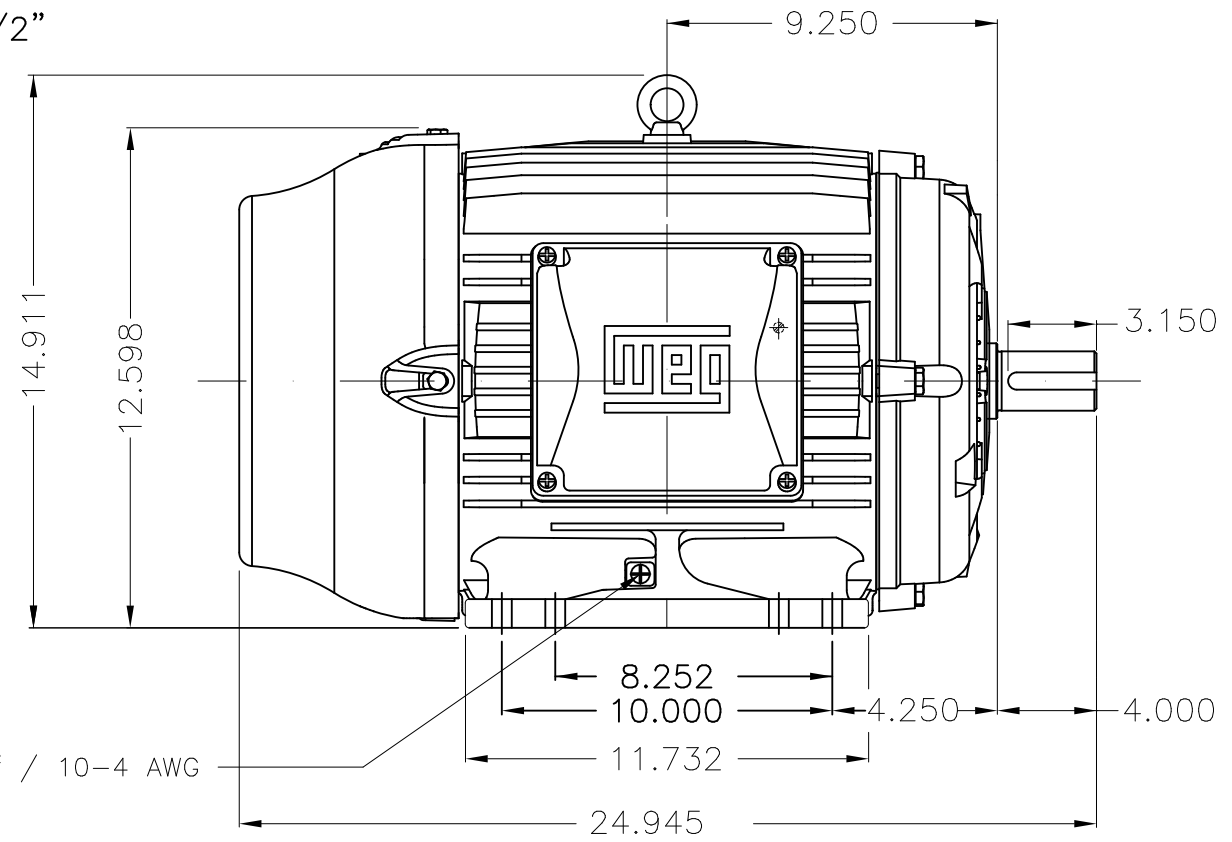

Grounding for leads 5.2–25 mm<sup>2</sup> / 10–4 AWG

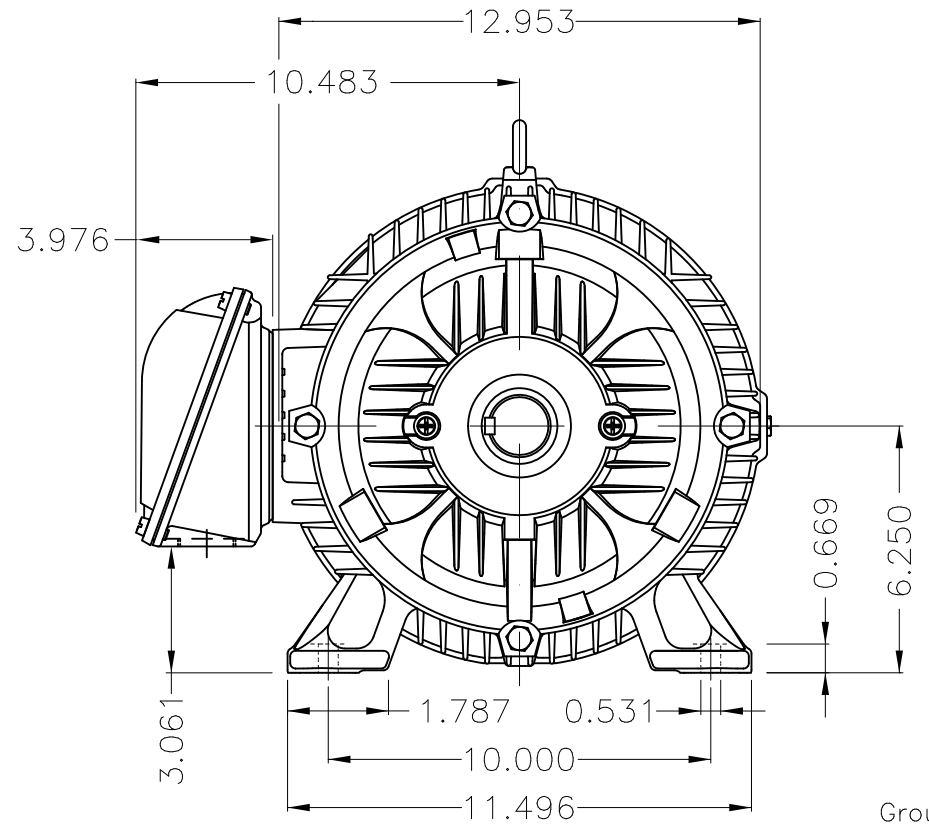

Grounding for leads 5.2–25 mm<sup>2</sup> / 10–4 AWG

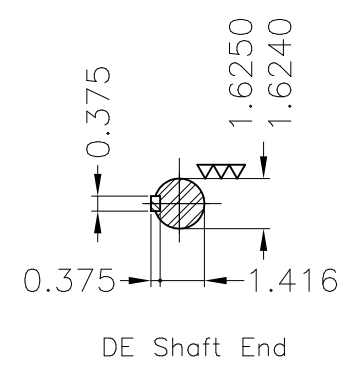

Color RAL 5009  
Painting plan 202E  
Mounting B3R(D)

ECM	LOC	SUMMARY OF MODIFICATIONS	EXECUTED	CHECKED	RELEASED	DATE	VER
EXECUTED	USERADMIN	THREE PH. W22 NEMA P.EFF MOTOR IEEE841					
CHECKED		FRAME 254/6T IP55 TEFC					
RELEASED		WEG code: 12385054					
REL DT	24.07.2017	WMO Jaragua do Sul	Product Engineering	SHEET	1 / 1		

5 HP 08 Poles 60Hz

A

