

THIS IS AN UPDATED REVISION, THE PREVIOUS ONE MUST BE DISREGARDED.

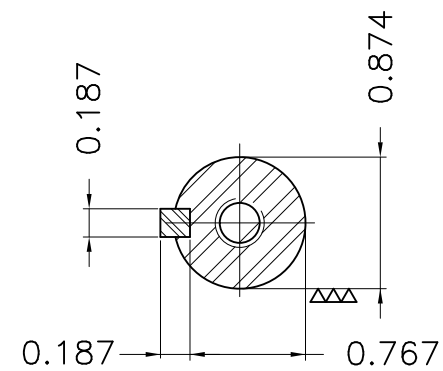

Mounting B34R(D)								
ECM	LOC	SUMMARY OF MODIFICATIONS		EXECUTED	CHECKED	RELEASED	DATE	VER
EXECUTED	USERADMIN		SINGLE PHASE MOTOR JM					
CHECKED			FRAME 145JM IP55 TEFC					
RELEASED			WEG code: 11047722					
REL DT	24.07.2017	WMO	Jaragua do Sul	Product Engineering	SHEET	1 / 1		

3 HP 02 Poles 60Hz

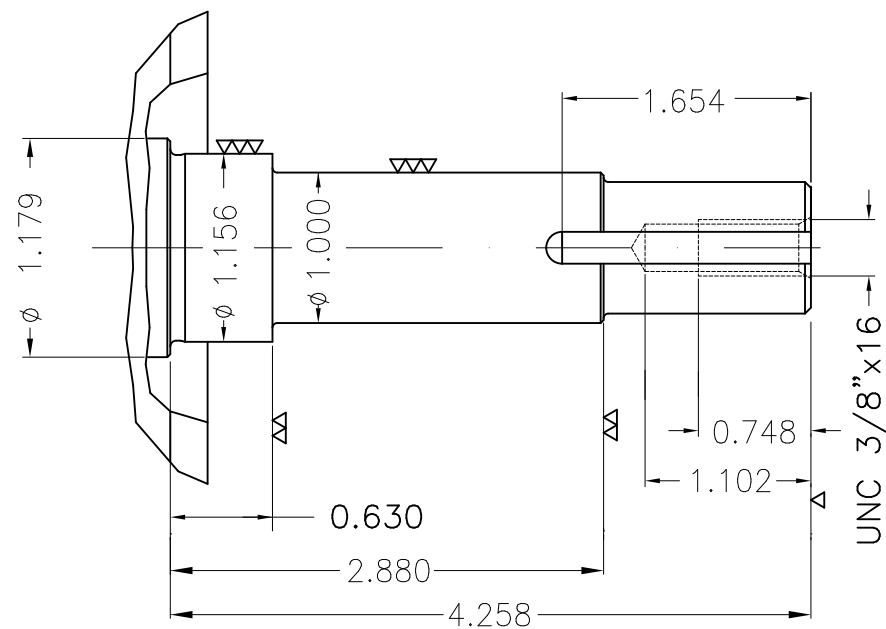
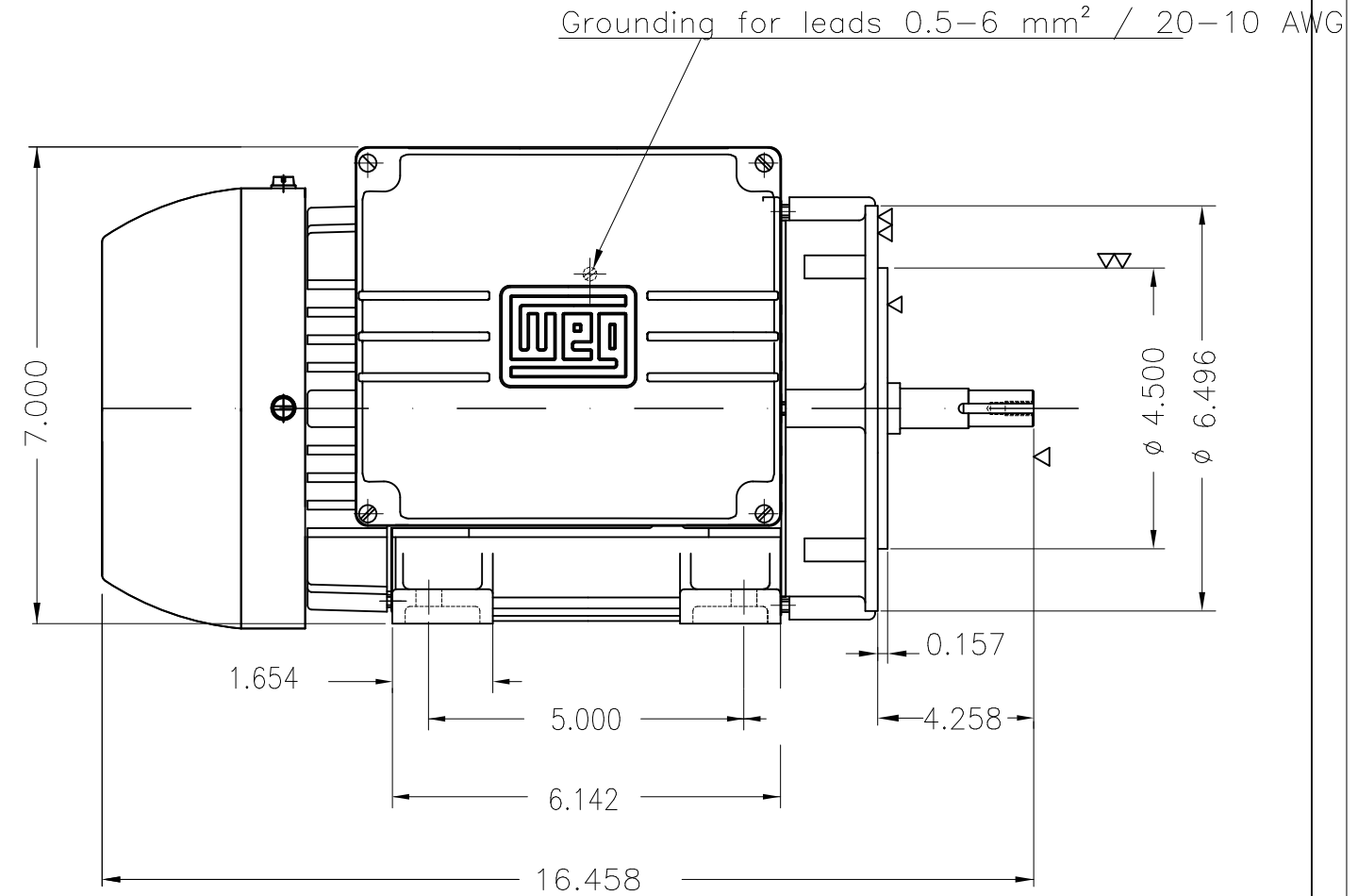
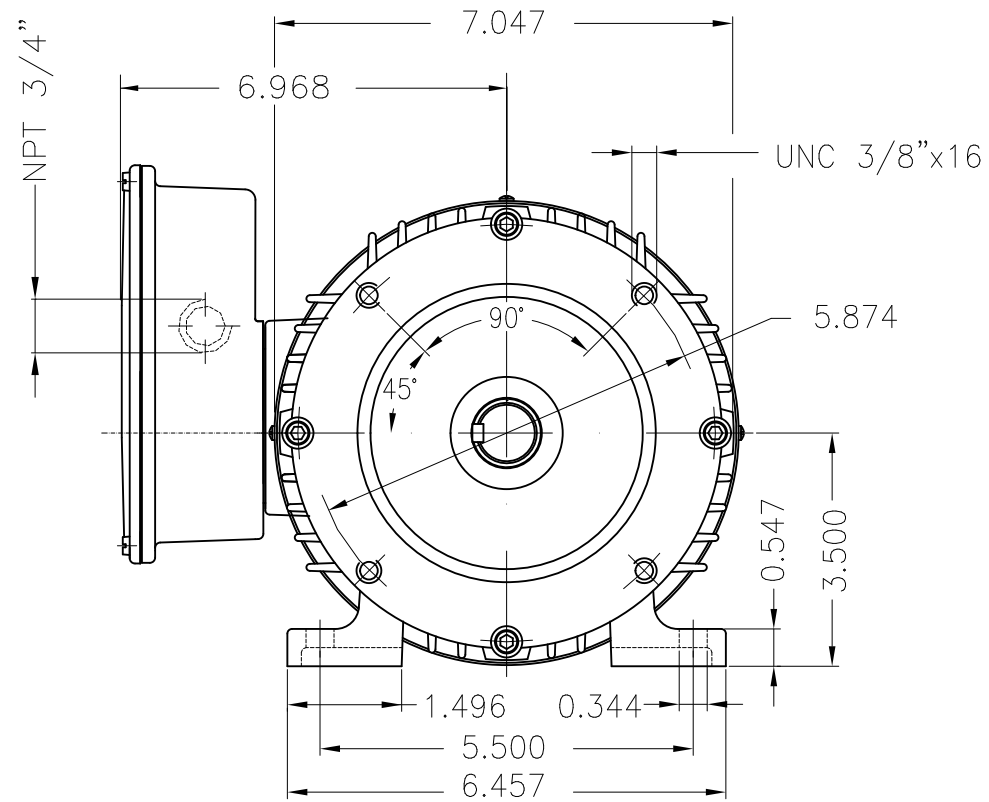