

DATE
February 18, 2004
CATALOG NO.
DJP0156

OUTLINE DIMENSIONS
3-PHASE INDUCTION MOTOR

MOTOR TYPE:
ASGAJP
FRAME NO. 284JP

Pole	HP	kW	Hz	VOLT	Syn. Speed r/min(rpm)
6	15	11.2	60	230/460	1200

Ins	Rating	Dimension in	Approx Weight	Bearings
F	CONT.	inches	297 lbs.	DE: 6311ZZC3 NDE: 6211ZZC3

Open Protected Drip-Proof Type. Squirrel-cage Rotor.

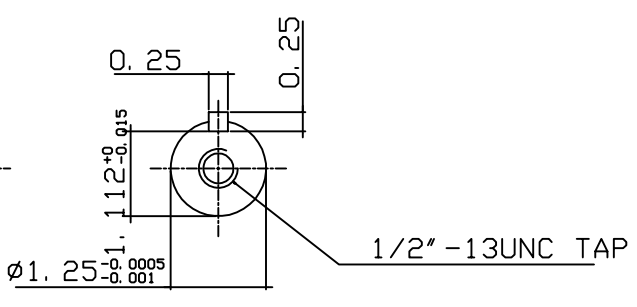
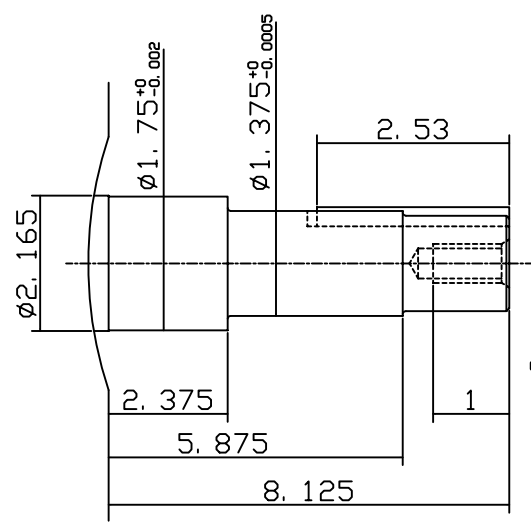
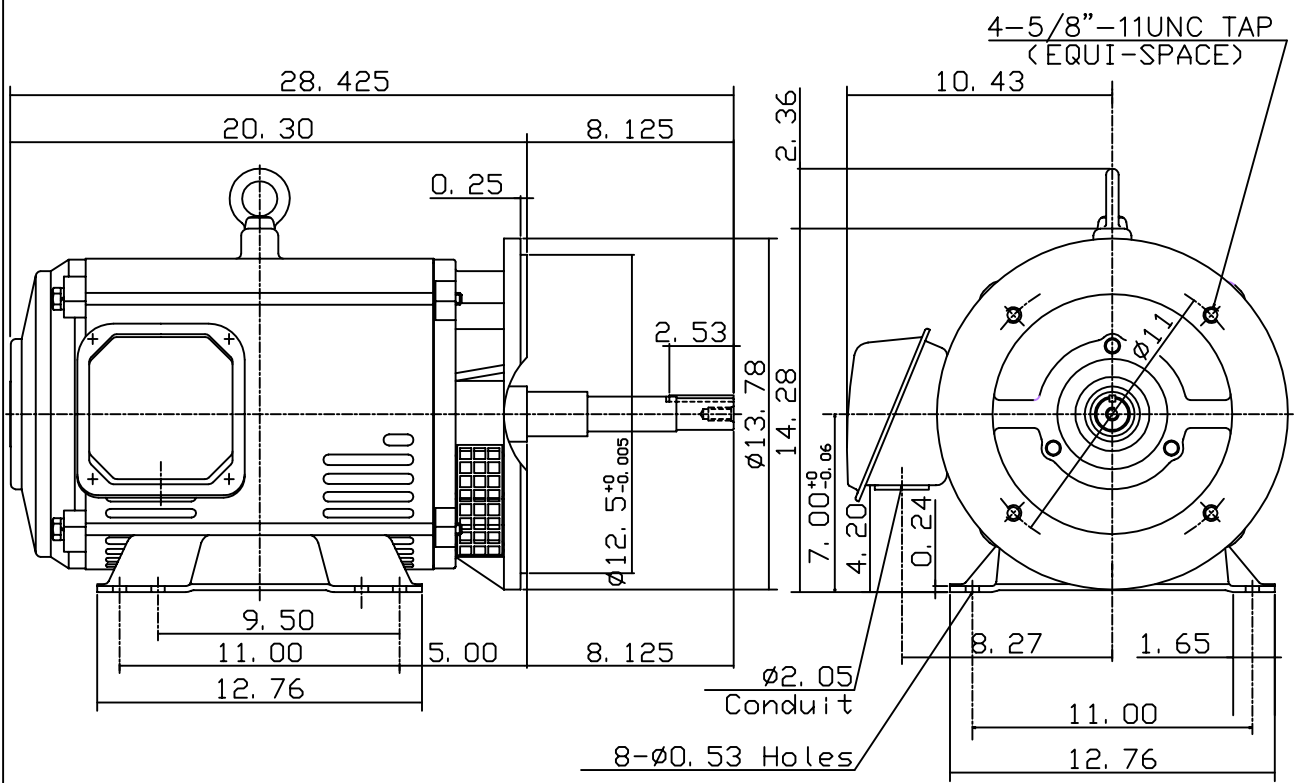

□		
---	--	--

DWN.	J. T. HWANG	04-11-03
CHKD.	J. S. JEAN	04-11-03
APPD.	Y. B. HUANG	04-11-03



DWG NO.
31049U529522