

Dimensões em polegada
Dimensions in inches

THIS IS AN UPDATED REVISION, THE
PREVIOUS ONE MUST BE DISREGARDED.

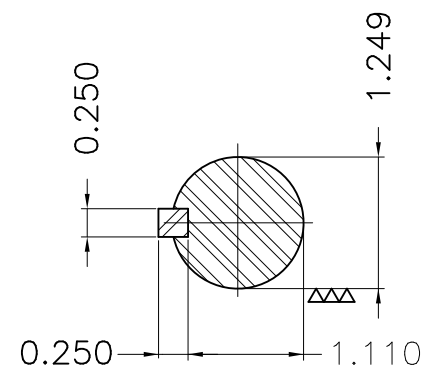
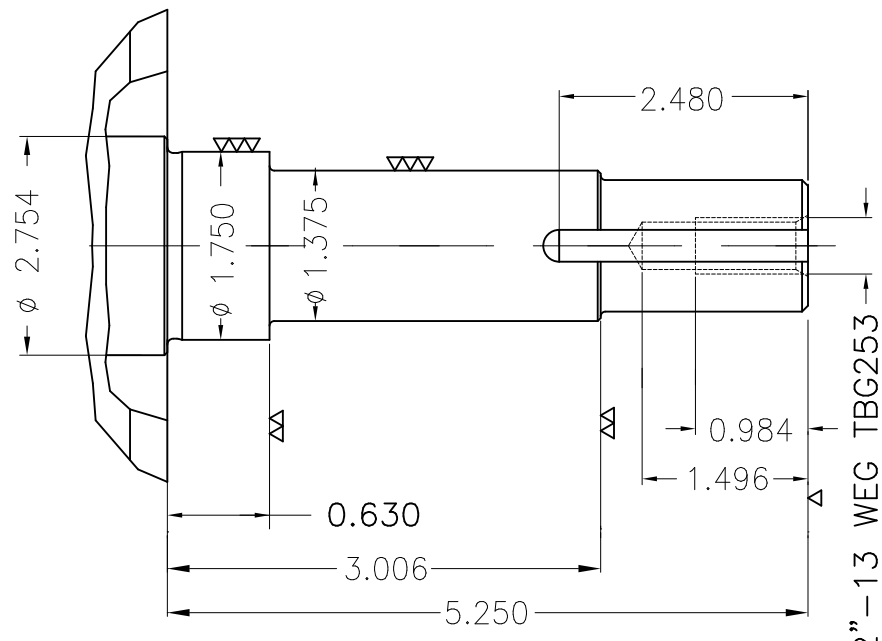
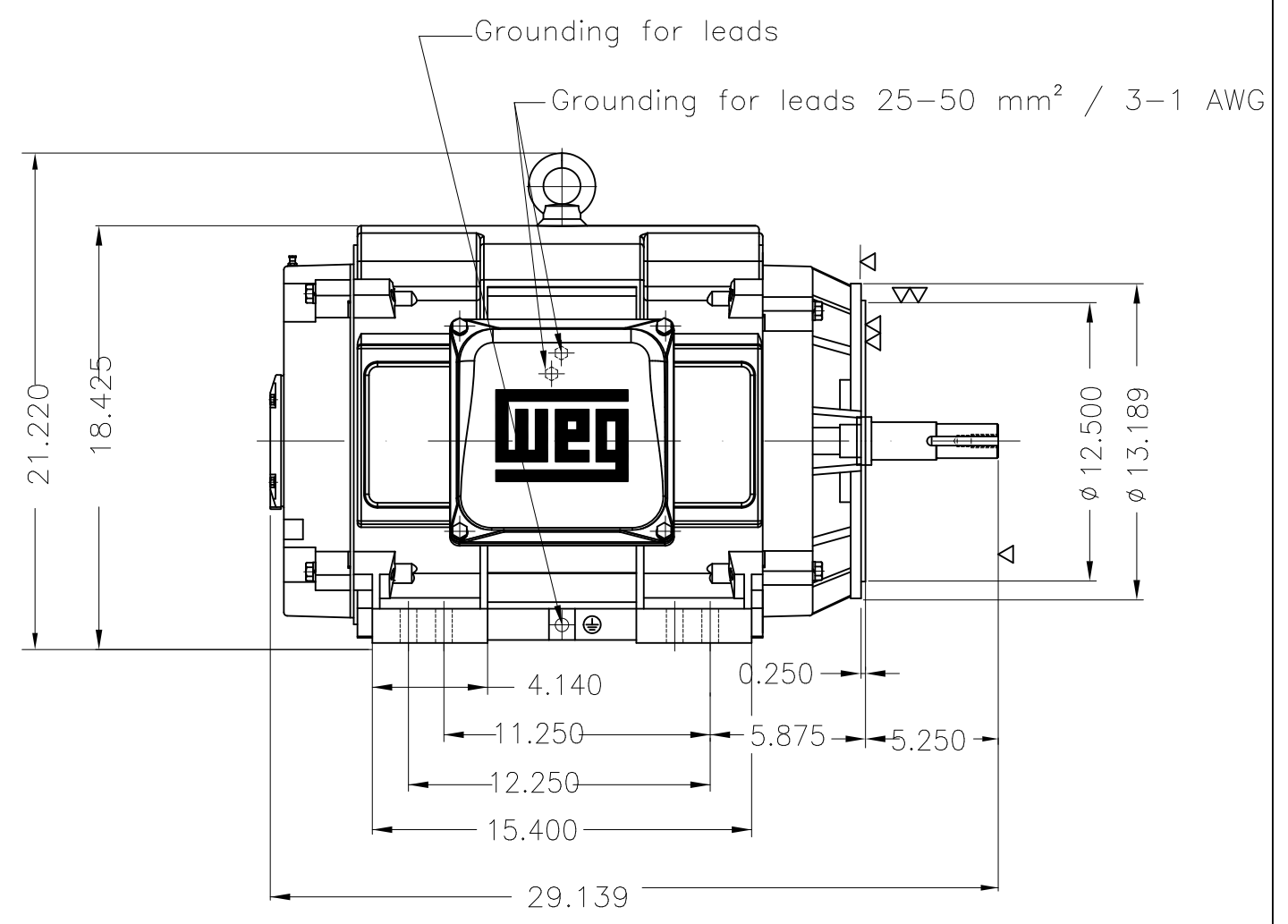
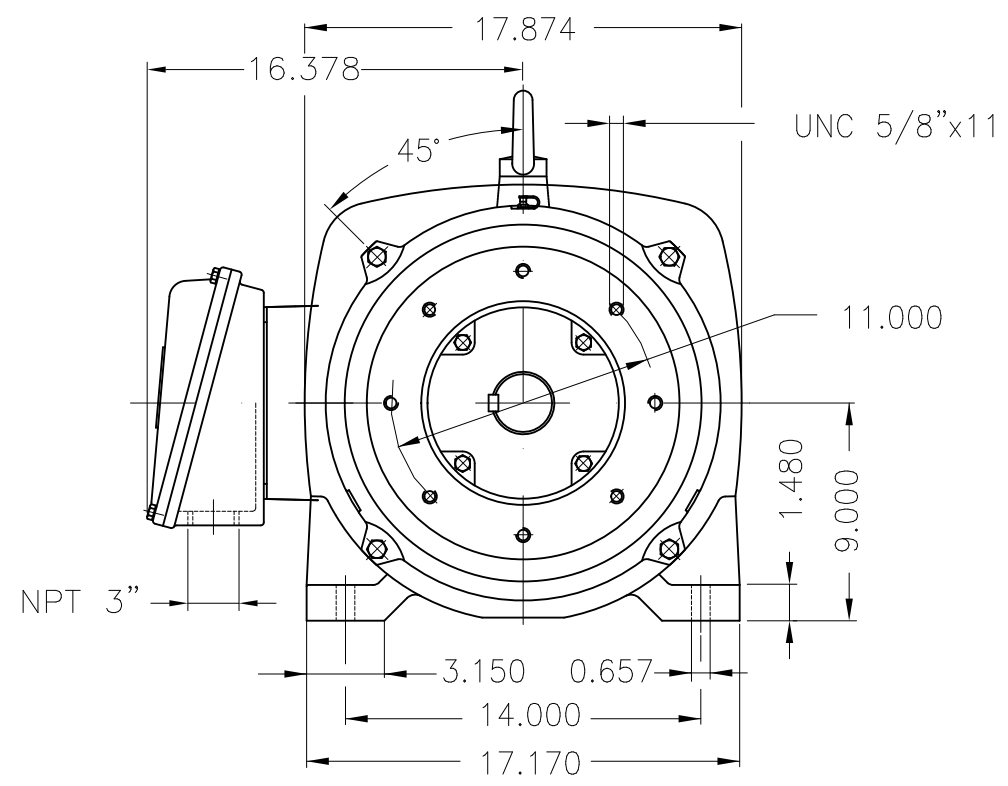

EUNC 1/2"-13 WEG TBG253

Color RAL 5009
Painting plan 203A
Mounting B34R(D)

ECM	LOC	SUMMARY OF MODIFICATIONS	EXECUTED	CHECKED	RELEASED	DATE	VER
EXECUTED	USERADMIN	THREE PHASE PREMIUM EFFICIENCY					
CHECKED		FRAME 364/5JM IP23 ODP					
RELEASED		WEG code: 11265451					
REL DT	24.07.2017	WMO Jaraguá do Sul	Product Engineering	SHEET	1 / 1		

100 HP 02 Poles 60Hz

