

**Dimensional Drawing**

Catalogue	Model	HP	Pole	kW	Rating	Voltage	Hz	RPM
VCN02545	AMRCNH	25	4	19	Continuous	575 V	60	1800

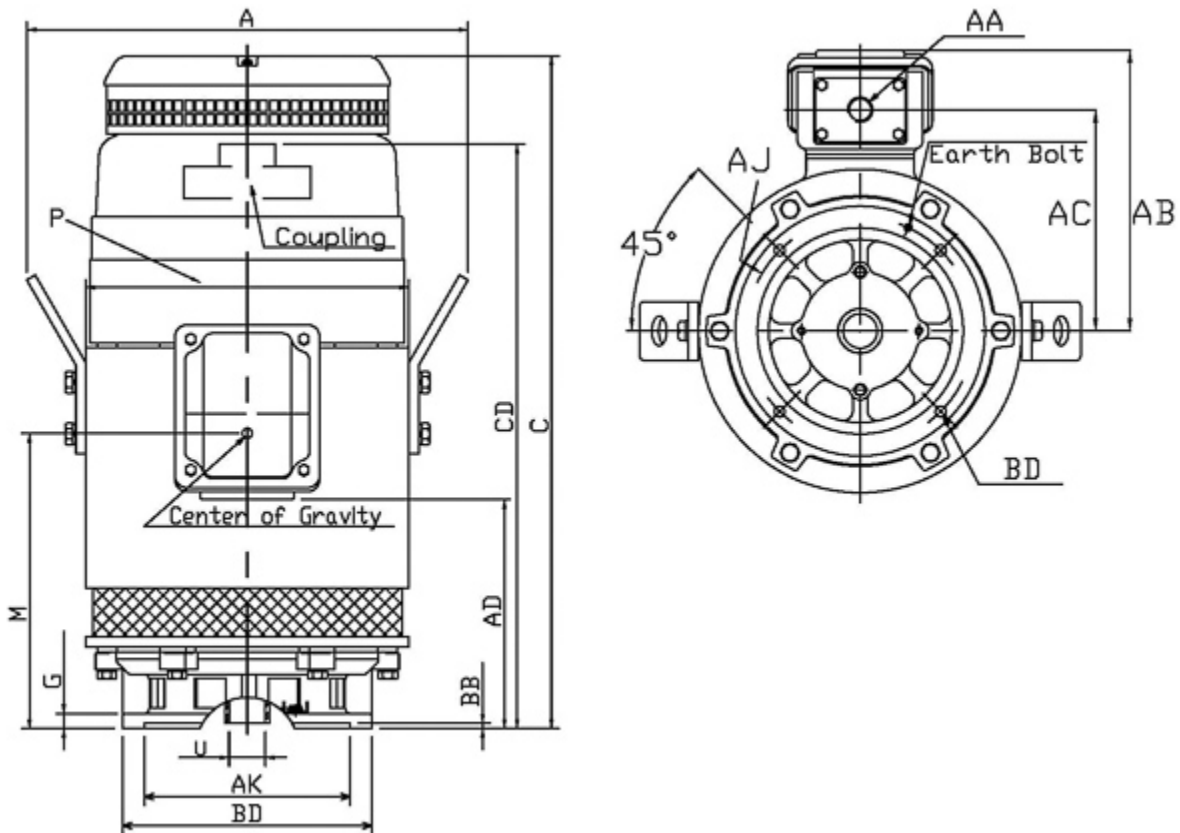

Frame Size	Mounting					A	B	C	CD	D	
	E	2F	2F2	H	BA						
284TP						19.25		28.25	24.75		
G	J	K	L	M	O	P	T	Key			Keyseat
						14.53		Width	Thick	Length	R
Terminal Housing				Aux Box		C/D Flange					
AA	AB	AC	XB	AE	AX	BB	AH	AK	BD	AJ	BF
1.5" NPT	14.58	11.18				0.25		8.25	10	9.125	0.44
Shaft Extension			Bearings		Approx. Weight Lbs	SPL dBA/3ft	Ins. Class	S.F.	Drive Method	Dimensions	
N-W	U	V	DE	NDE							
	1.378		6311ZZC3	7312B	417	0	F	1.15	Direct Coupling	Inches	

### Technical Data Sheet

Motor Type: AMRCNH

Catalogue No: VCN02545

#### Nameplate Information

HP	Pole	RPM	Frame	Voltage	Hz	Phase
25	4	1765	284TP	575	60	3
Enclosure	Ins. Class	Service Factor	Time Rating	NEMA Design	Rated Amb.	Rated Altitude
WPI	F	1.15	Continuous	B	-40 to 40 °C	<3300 ft

#### Typical Performance

Efficiency (%)				Power Factor (%)		
Full Load		3/4 Load	1/2 Load	Full Load	3/4 Load	1/2 Load
Nom.	Min.					
93.6	92.4	93.5	93.0	85.0	82.0	74.0
Torque				Current (A)		
Full Load (lb-ft)	Locked Rotor (% FLT)	Pull Up (% FLT)	Break Down (% FLT)	No Load	Full Load	Locked Rotor
74.36	210	165	235	7.2	23.5	146
NEMA KVA Code	Inertia (WR <sup>2</sup> )			Safe Stall Time (s)		Noise Level Sound Press. dB(A)
	Rotor (lb-ft <sup>2</sup> )	NEMA Load (lb-ft <sup>2</sup> )	Max. Allowable (lb-ft <sup>2</sup> )	Cold	Hot	
G	3.713	122	179	17	12	0

#### VFD Duty Information

Speed Range			VFD		S.F.
Constant Torque	Variable Torque	Constant Power	Carrier	Type	
0	15-60Hz:	0	≤ 3 kHz	VPWM or CPWM	1.0 Only

#### Additional Information

Bearings		Approx. Weight
DE	NDE	lbs
6311ZZC3	7312B	417

#### Hazardous Locations Information

0	
0	
0	
Temp Code (Sinewave / VFD)	0 / 0