

Dimensões em polegada  
Dimensions in inches

THIS IS AN UPDATED REVISION, THE  
PREVIOUS ONE MUST BE DISREGARDED.

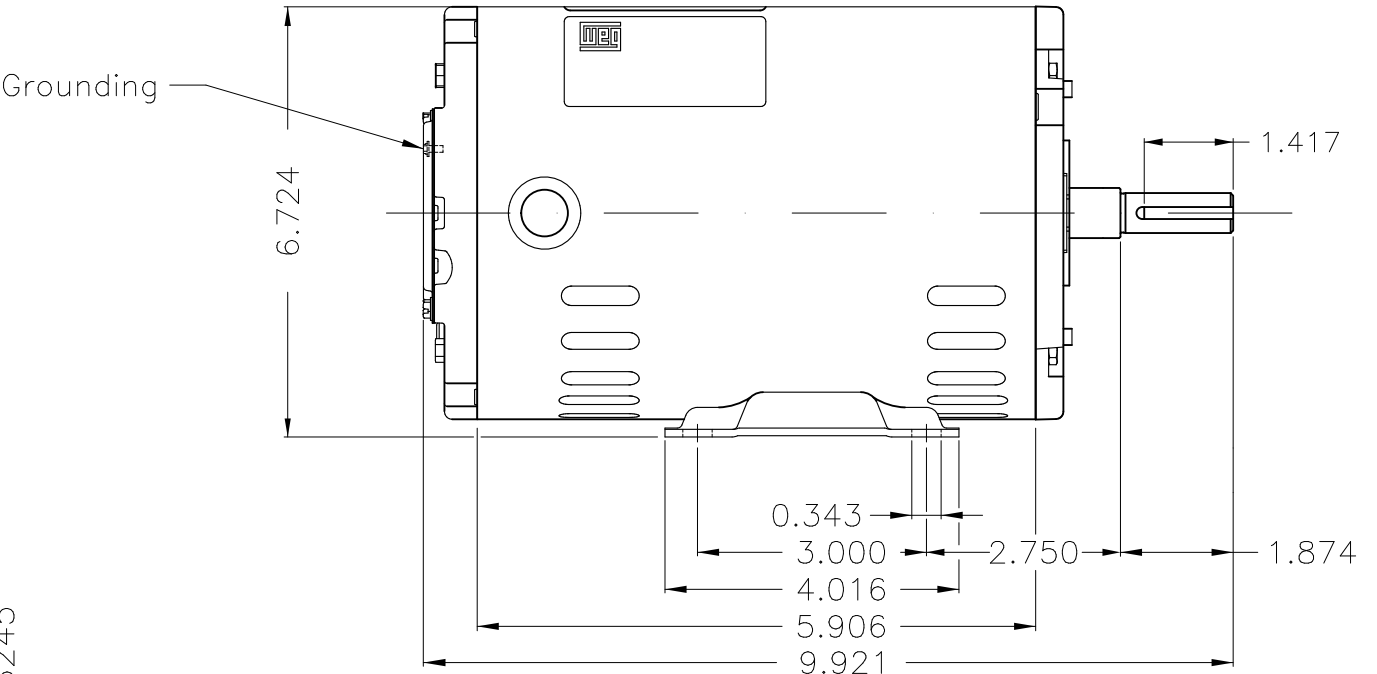
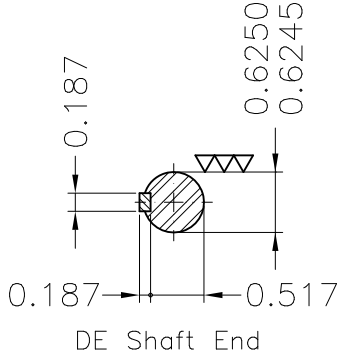
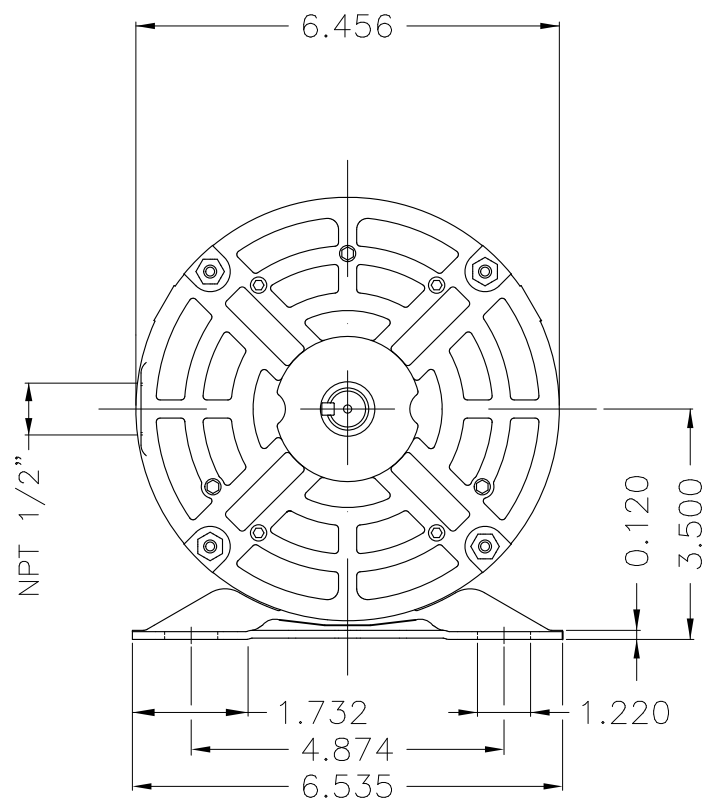

Without coating									
Mounting F-1/B3R(D)									
ECM	LOC	SUMMARY OF MODIFICATIONS			EXECUTED	CHECKED	RELEASED	DATE	VER
EXECUTED	USERADMIN	THREE PHASE ODP ROLLED STEEL PREM. EFF.							
CHECKED		FRAME 56 ODP							
RELEASED		WEG code: 12808933							
REL DT	24.07.2017	WMO	Jaragua do Sul	Product Engineering	SHEET	1 / 1			

0.25 HP    04 Poles    60Hz

A

