

Dimensões em polegada
Dimensions in inches

THIS IS AN UPDATED REVISION, THE
PREVIOUS ONE MUST BE DISREGARDED.

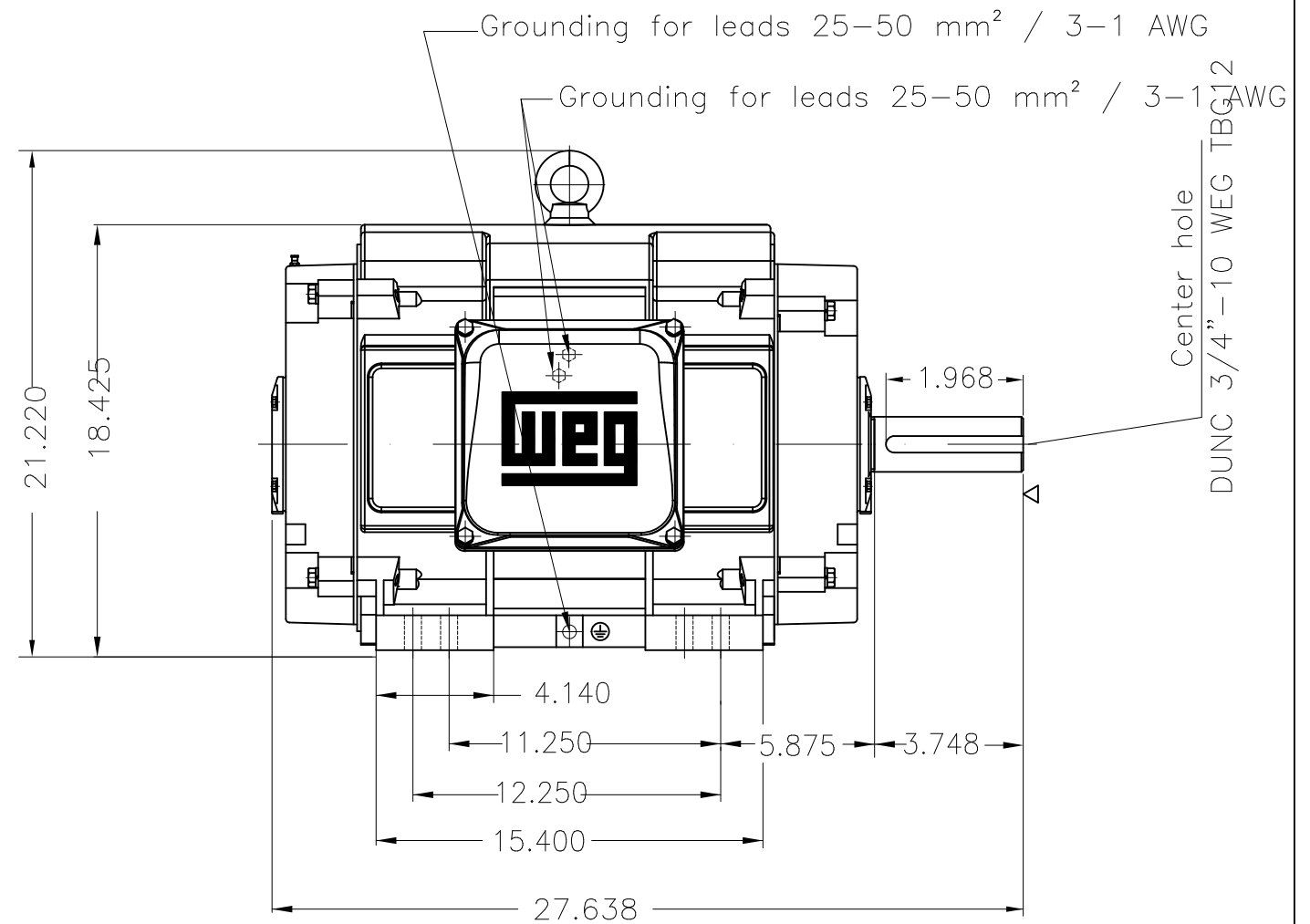
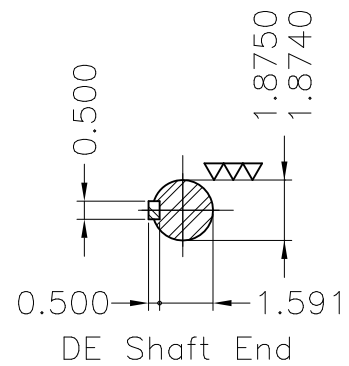
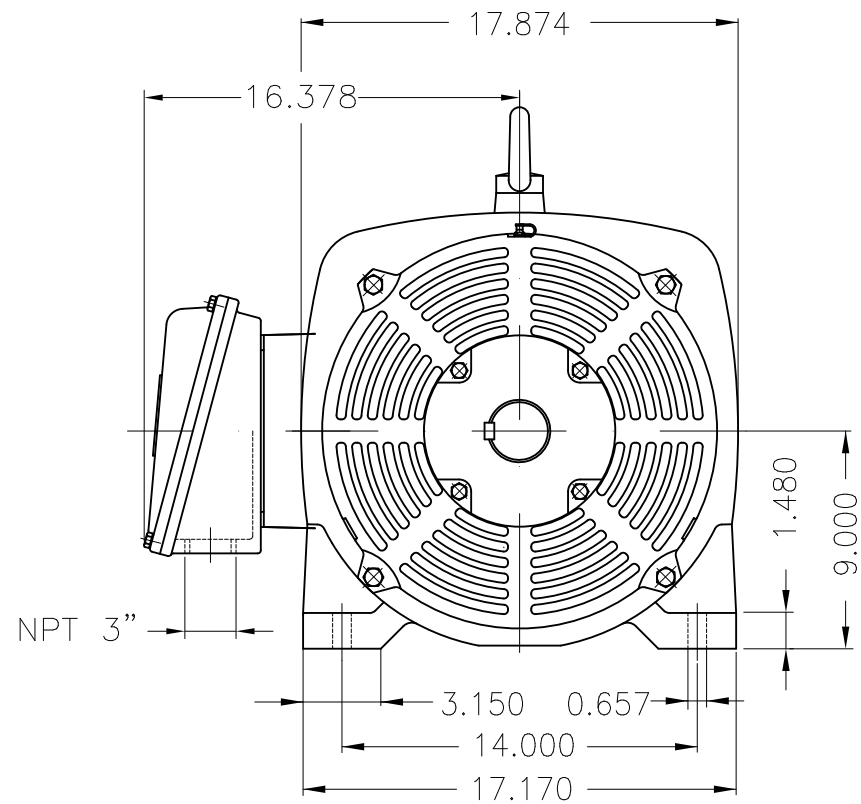

Color RAL 5009
Painting plan 203A
Mounting B3R(D)

ECM	LOC	SUMMARY OF MODIFICATIONS	EXECUTED	CHECKED	RELEASED	DATE	VER
EXECUTED	USERADMIN	THREE PHASE NEMA P. EFF MOTOR					
CHECKED		FRAME 364/5TS IP23 ODP					
RELEASED		WEG code: 10015870					
REL DT	24.07.2017	WMO Jaragua do Sul	Product Engineering	SHEET	1 / 1		

100 HP 02 Poles 60Hz

A

