

DATE
MAY 2, 2004
CATALOG NO.
XV0102C

OUTLINE DIMENSIONS
3-PHASE INDUCTION MOTOR

MOTOR TYPE:
AEUHXF
FRAME NO. 215TC

Pole	HP	KW	Hz	VOLT	Syn. Speed r/min(rpm)
2	10	7.5	60	230/460	3600

Ins	Rating	Dimension in	Approx Weight	Bearings
F	CONT.	inches	241 lbs.	DE: 6308ZZ NDE: 6306ZZ

Totally Enclosed Fan-Cooled Type. Squirrel-Cage Rotor.

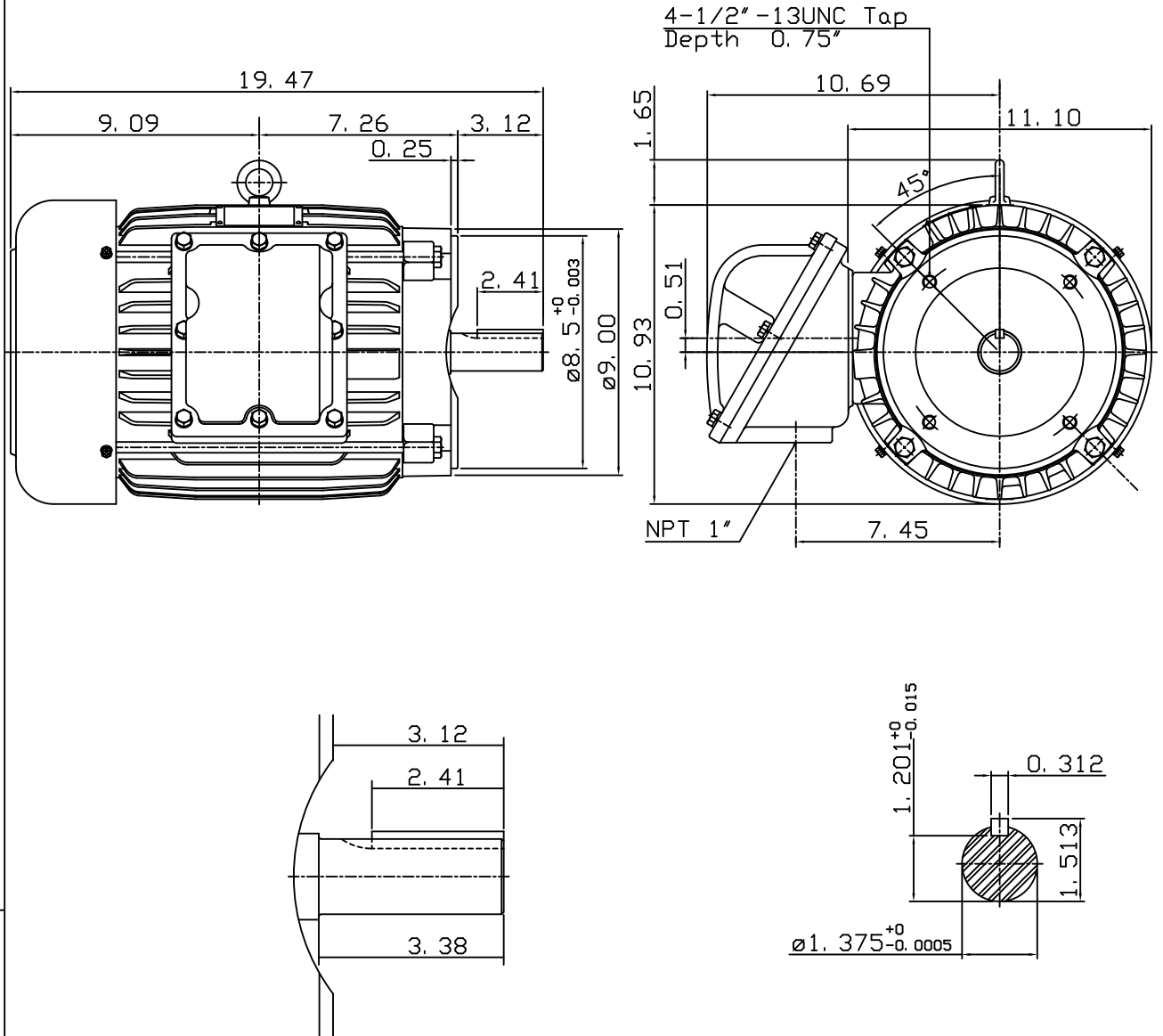

Note:

- Explosion proof:
Class I Group D and
Class II Group E, F, G.

DWN.	J. H. LIANG	11-28-00
CHKD.	C. S. LO	03-22-01
APPD.	Y. B. HUANG	03-22-01

TECO Westinghouse

DWG NO.
31049U55401