

DATE
Sept. 8, 2005
CAT. #: EPO056

OUTLINE DIMENSIONS
3-PHASE INDUCTION MOTOR

MOTOR TYPE:
AEHH8N
FRAME NO. 215T

Pole	HP	kW	Hz	VOLT	Syn. Speed r/min(rpm)
6	5	3.73	60	230/460	1200

Ins	Rating	Dimension in	Approx Weight	Bearings	
F	CONT.	inches	193 lbs.	DE: 6308ZZ	NDE: 6306ZZ

Totally Enclosed Fan Cooled Squirrel Cage Rotor.

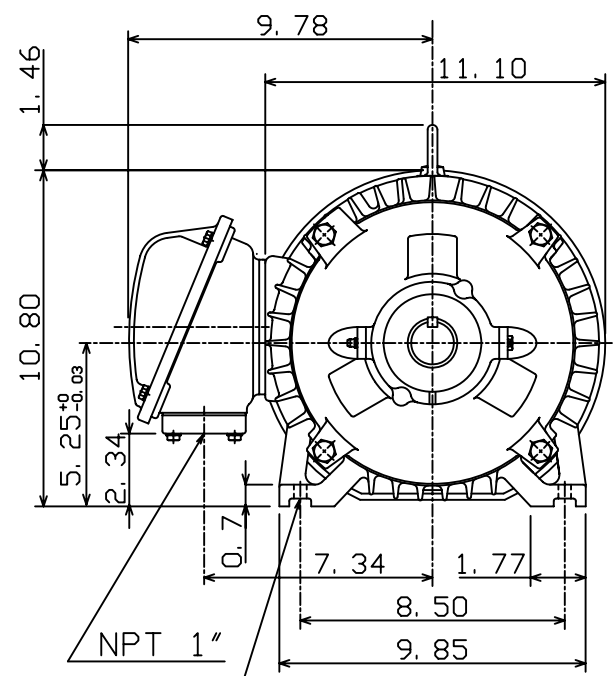
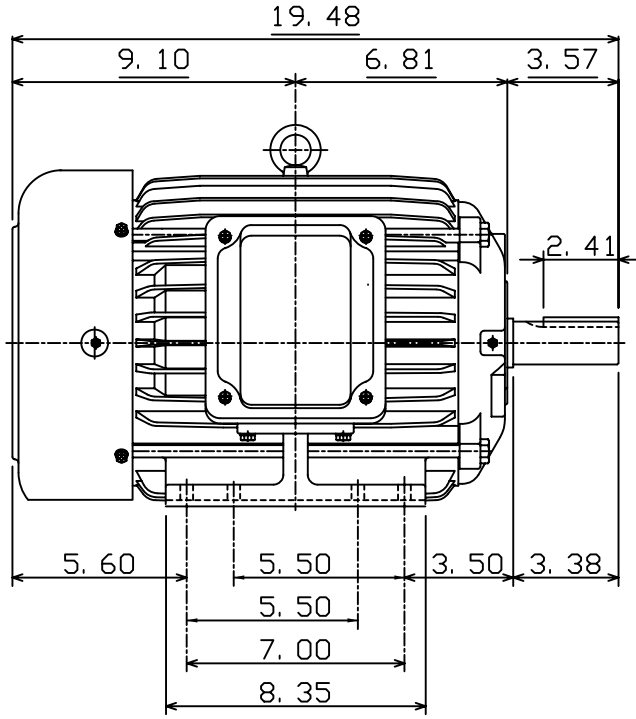

8-Ø0.41 Holes
(215T&213T)

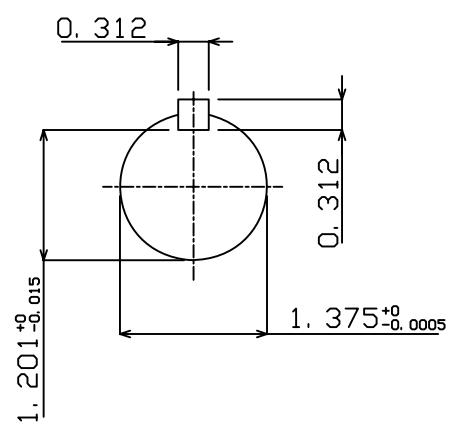

DWN.	C. S. LO	12-22-04
CHKD.	C. S. LO	12-27-04
APPD.	M. C. TSAI	12-27-04



DWG NO.
31057H356100