

Dimensional Drawing

Catalogue	Model	HP	Pole	kW	Rating	Voltage	Hz	RPM
APH0028-841	AEHH8B	2	8	1.5	Continuous	460 V	60	900

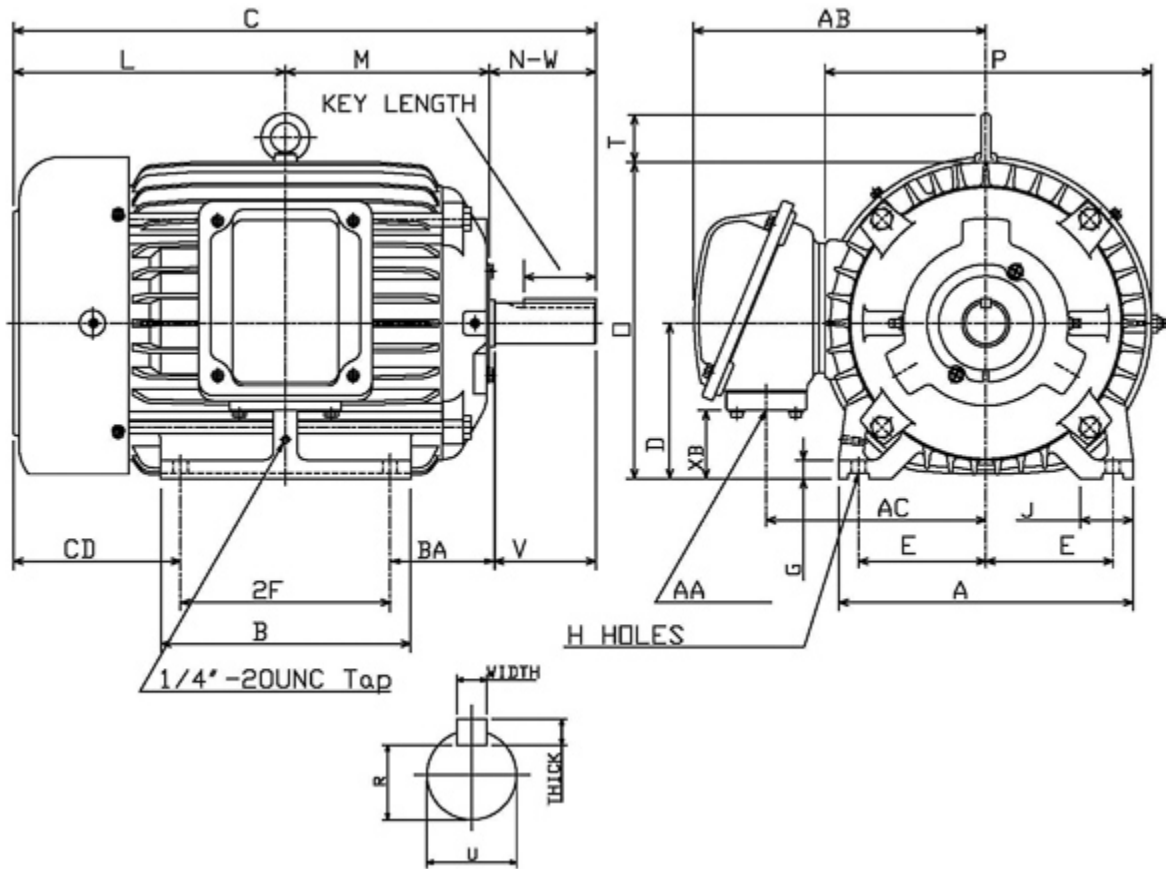

Frame Size	Mounting					A	B	C	CD	D	
	E	2F	2F2	H	BA						
213T	4.25	5.5		0.41	3.5	9.85	6.89	18.26		5.25	
G	J	K	L	M	O	P	T	Key			Keyseat
0.7	1.75		8.63	6.1	10.62	11.1	1.65	Width	Thick	Length	R
								0.312	0.312	2.41	1.201
Terminal Housing			Aux Box			C/D Flange					
AA	AB	AC	XB	AE	AX	BB	AH	AK	BD	AJ	BF
NPT1"	9.78	7.34	2.34								
Shaft Extension			Bearings		Approx. Weight Lbs	SPL dBA/3ft	Ins. Class	S.F.	Drive Method	Dimensions	
N-W	U	V	DE	NDE							
3.38	1.375	3.3	6308ZC3	6306ZC3	134	52	F	1.15	Direct Coupling / Belt Drive	Inches	

Technical Data Sheet

Motor Type: AEHH8B

Catalogue No: APH0028-841

Nameplate Information

HP	Pole	RPM	Frame	Voltage	Hz	Phase
2	8	865	213T	460	60	3
Enclosure	Ins. Class	Service Factor	Time Rating	NEMA Design	Rated Amb.	Rated Altitude
TEFC	F	1.15	Continuous	B	-40 to 40 °C	<3300 ft

Typical Performance

Efficiency (%)				Power Factor (%)		
Full Load		3/4 Load	1/2 Load	Full Load	3/4 Load	1/2 Load
Nom.	Min.					
85.5	82.5	84.0	82.5	64.0	55.0	42.5
Torque				Current (A)		
Full Load (lb-ft)	Locked Rotor (% FLT)	Pull Up (% FLT)	Break Down (% FLT)	No Load	Full Load	Locked Rotor
12.14	190	170	275	2.4	3.4	25
NEMA KVA Code	Inertia (WR ²)			Safe Stall Time (s)		Noise Level Sound Press. dB(A)
	Rotor (lb-ft ²)	NEMA Load (lb-ft ²)	Max. Allowable (lb-ft ²)	Cold	Hot	
L	0.586	59	285	66	46	52

VFD Duty Information

Speed Range			VFD		S.F.
Constant Torque	Variable Torque	Constant Power	Carrier	Type	
6-60Hz	3-60Hz	60-120Hz	≤ 5 kHz	VPWM or CPWM	1.0 Only

Additional Information

Bearings		Approx. Weight
DE	NDE	lbs
6308ZC3	6306ZC3	134

Hazardous Locations Information

CSA Certified	
Class I, Div 2, Groups B, C & D	
Class I, Zone 2, Groups IIB+H2, IIB & IIA	
Temp Code (Sinewave / VFD)	T3A / T3A