

Dimensões em polegada
Dimensions in inches

THIS IS AN UPDATED REVISION, THE
PREVIOUS ONE MUST BE DISREGARDED.

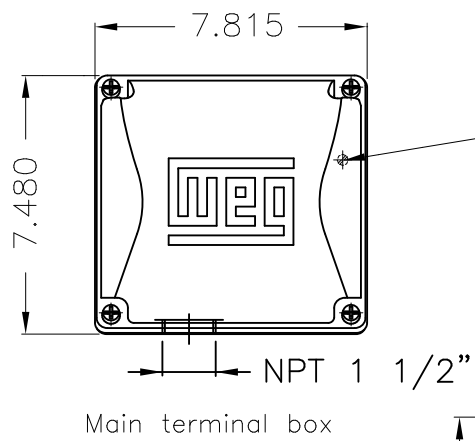

Grounding for leads 5.2–25 mm² / 10–4 AWG

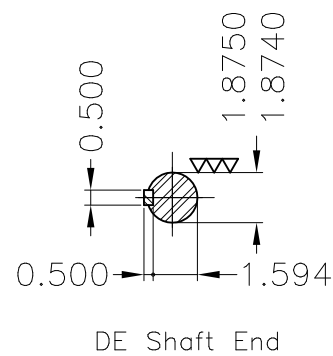
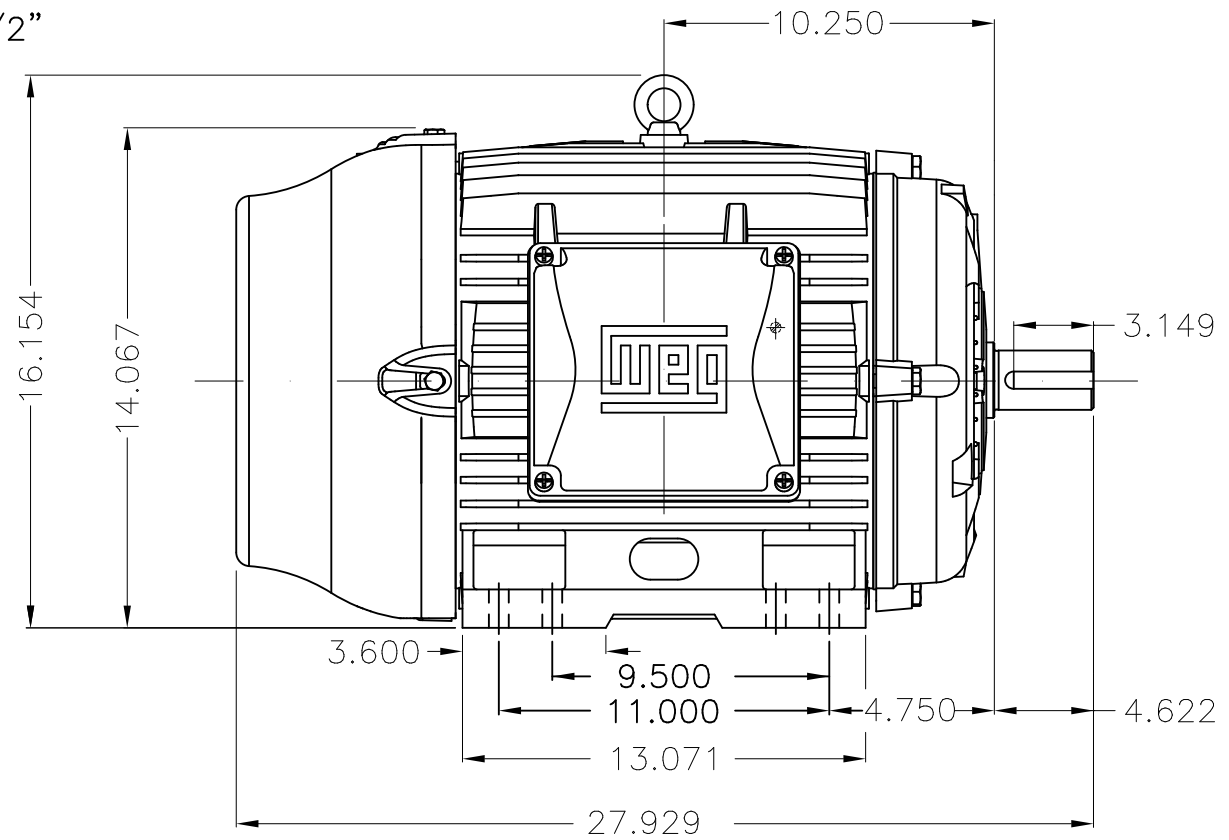
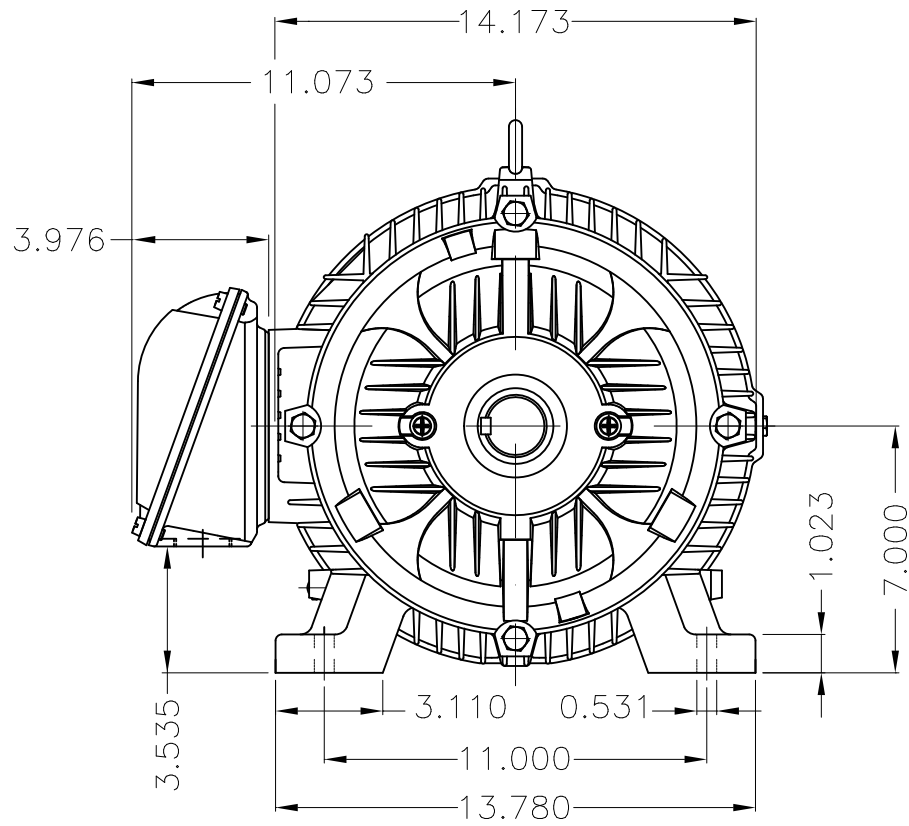

Color RAL 5009
Painting plan 203A
Mounting B3R(D)

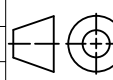
ECM	LOC	SUMMARY OF MODIFICATIONS			EXECUTED	CHECKED	RELEASED	DATE	VER
EXECUTED	USERADMIN		THREE PHASE W22 MOTOR - NEMA PREMIUM EFF						
CHECKED			FRAME 284/6T IP55 TEFC						
RELEASED			WEG code: 12447100						
REL DT	24.07.2017	WMO	Jaragua do Sul	Product Engineering	SHEET	1 / 1			

25 HP 04 Poles 60Hz

A

