

DATE
DEC. 13, 2010
CAT. #: NP0256

OUTLINE DIMENSIONS
3-PHASE INDUCTION MOTOR

MOTOR TYPE:
AEHH8P
FRAME NO. 324T

Pole	HP	kW	Hz	VOLT	Syn.Speed r/min(rpm)
6	25	18.7	60	230/460	1200

Ins	Rating	Dimension in	Approx Weight	Bearings	
F	CONT.	inch	612 lbs.	DE: 6312	NDE: 6212

Totally Enclosed Fan-Cooled Type. Squirrel-cage Rotor.

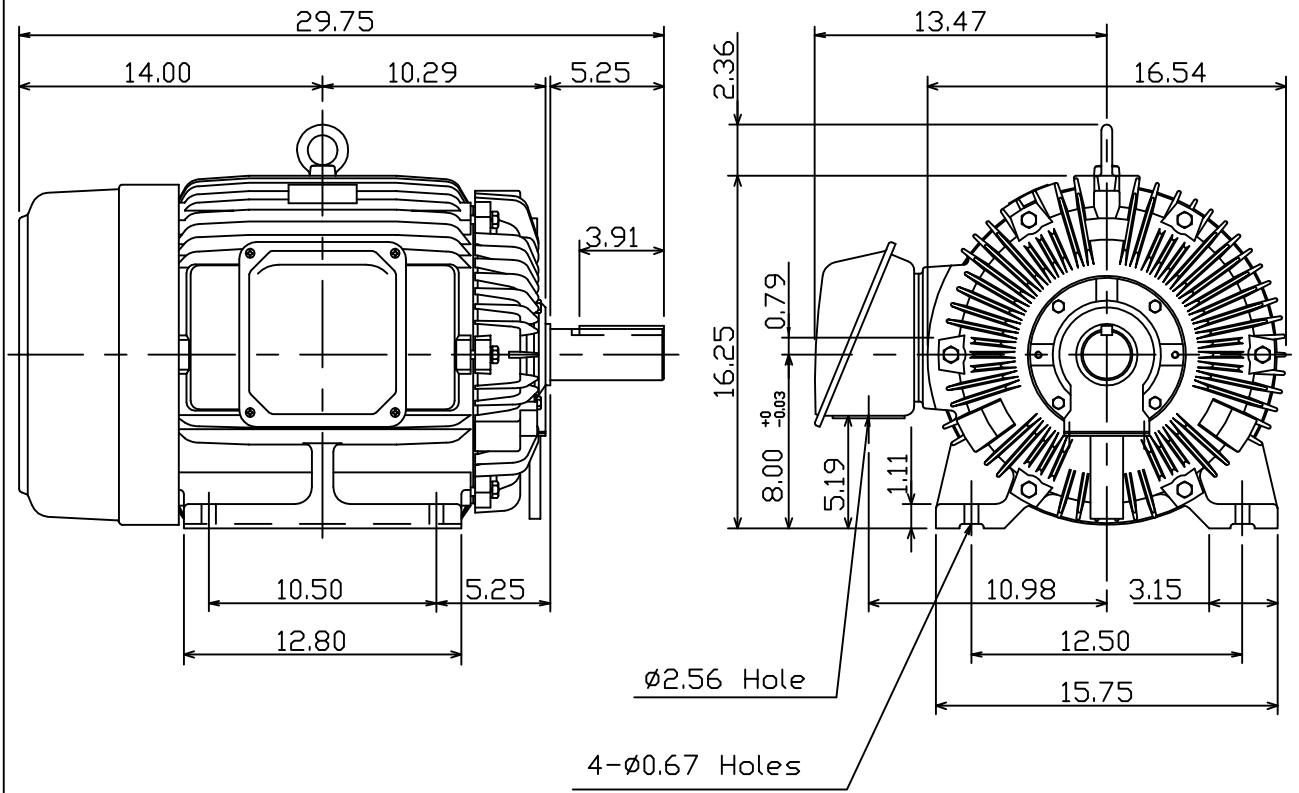

12.06.10 郭耿良

DWN, J.H.LIANG	05 :20 99
CHKD, C.H.KAD	06 :15 99
APPD, Y.B.HUANG	06 :15 99



DWG NO.
31049J355272