

Dimensional Drawing

Catalogue	Model	HP	Pole	kW	Rating	Voltage	Hz	RPM
PDH0404	AEHH8N	40	4	30	Continuous	230 / 460 V	60	1800

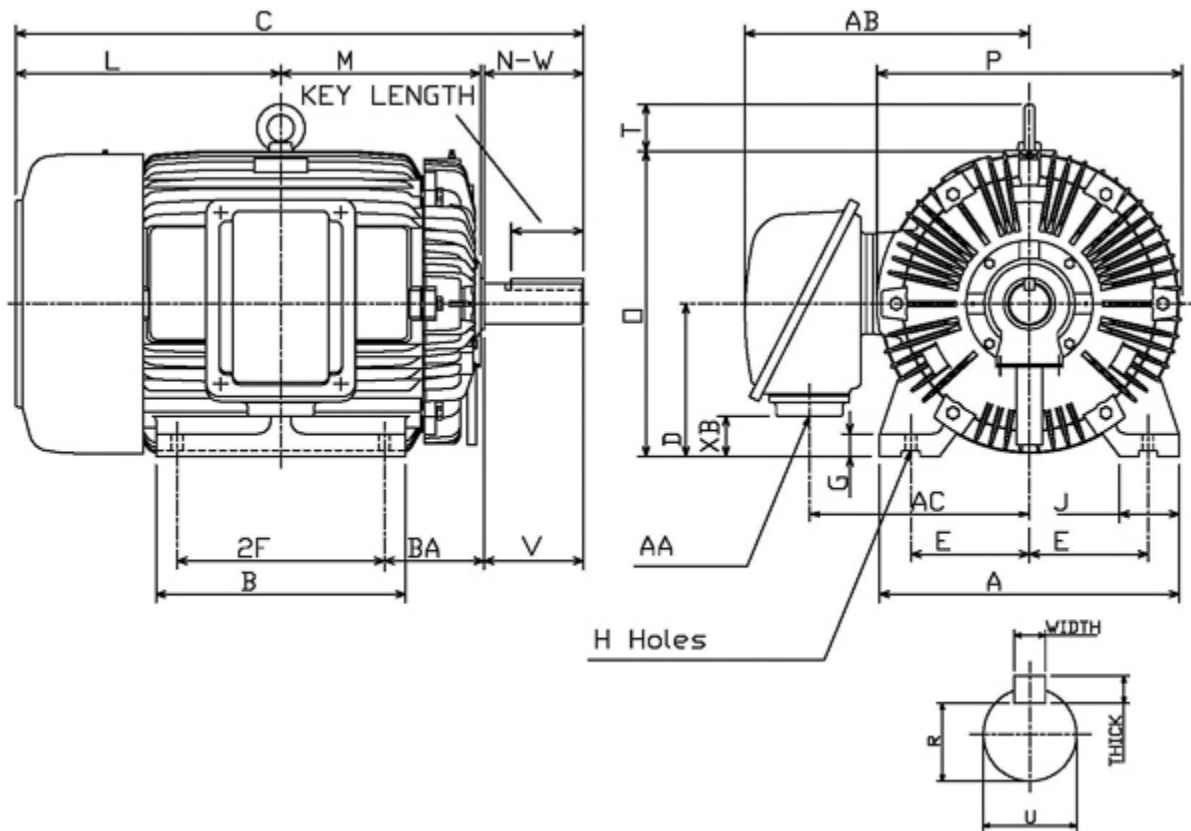

Frame Size	Mounting					A	B	C	CD	D	
	E	2F	2F2	H	BA						
324T	6.25	10.5		0.66	5.25	15.75	12.8	29.93		8	
G	J	K	L	M	O	P	T	Key			Keyseat
								Width	Thick	Length	R
1.1	3.15		14.18	10.29	16.27	16.54	2.32	0.5	0.5	3.91	1.845
Terminal Housing			Aux Box			C/D Flange					
AA	AB	AC	XB	AE	AX	BB	AH	AK	BD	AJ	BF
2 NPT	14.65	11.3	3.59								
Shaft Extension			Bearings		Approx. Weight Lbs	SPL dBA/3ft	Ins. Class	S.F.	Drive Method	Dimensions	
N-W	U	V	DE	NDE							
5.25	2.125	5.15	6312	6212	658	74	F	1.15	Direct Coupling / Belt Drive	Inches	

Technical Data Sheet

Motor Type: AEHH8N

Catalogue No: PDH0404

Nameplate Information

HP	Pole	RPM	Frame	Voltage	Hz	Phase
40	4	1770	324T	230 / 460	60	3
Enclosure	Ins. Class	Service Factor	Time Rating	NEMA Design	Rated Amb.	Rated Altitude
TEFC	F	1.15	Continuous	B	-40 to 40 °C	<3300 ft

Typical Performance

Efficiency (%)				Power Factor (%)		
Full Load		3/4 Load	1/2 Load	Full Load	3/4 Load	1/2 Load
Nom.	Min.					
94.1	93.0	94.5	94.5	86.0	84.5	78.5
Torque				Current (A)		
Full Load (lb-ft)	Locked Rotor (% FLT)	Pull Up (% FLT)	Break Down (% FLT)	No Load	Full Load	Locked Rotor
118.70	205	170	220	21.2 / 10.6	92.6 / 46.3	580 / 290
NEMA KVA Code	Inertia (WR ²)			Safe Stall Time (s)		Noise Level Sound Press. dB(A)
	Rotor (lb-ft ²)	NEMA Load (lb-ft ²)	Max. Allowable (lb-ft ²)	Cold	Hot	
G	8.624	189.0	375.0	25	18	74

VFD Duty Information

Speed Range			VFD		S.F.
Constant Torque	Variable Torque	Constant Power	Carrier	Type	
6-60Hz	3-60Hz	60-90Hz	≤ 5 kHz	VPWM or CPWM	1.0 Only

Additional Information

Bearings		Approx. Weight
DE	NDE	lbs
6312	6212	658

Hazardous Locations Information

CSA Certified	
Class I, Div 2, Groups B, C & D	
Class I, Zone 2, Groups IIB+H2, IIB & IIA	
Temp Code (Sinewave / VFD)	T3C / T3B