

Dimensões em polegada
Dimensions in inches

THIS IS AN UPDATED REVISION, THE
PREVIOUS ONE MUST BE DISREGARDED.

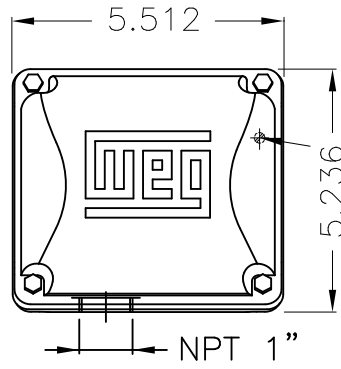

Grounding for leads 2-10 mm² / 14-7 AWG

Main terminal box

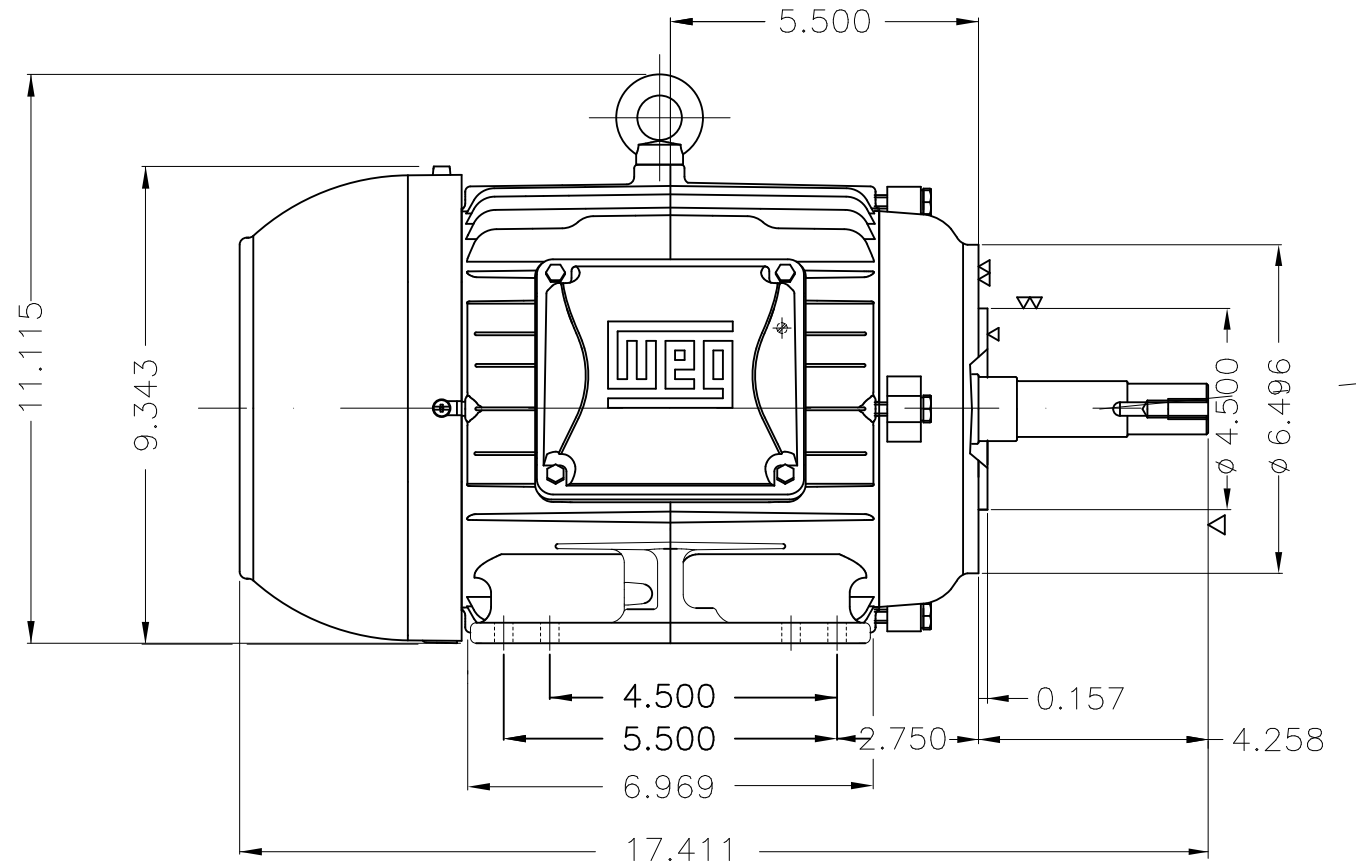
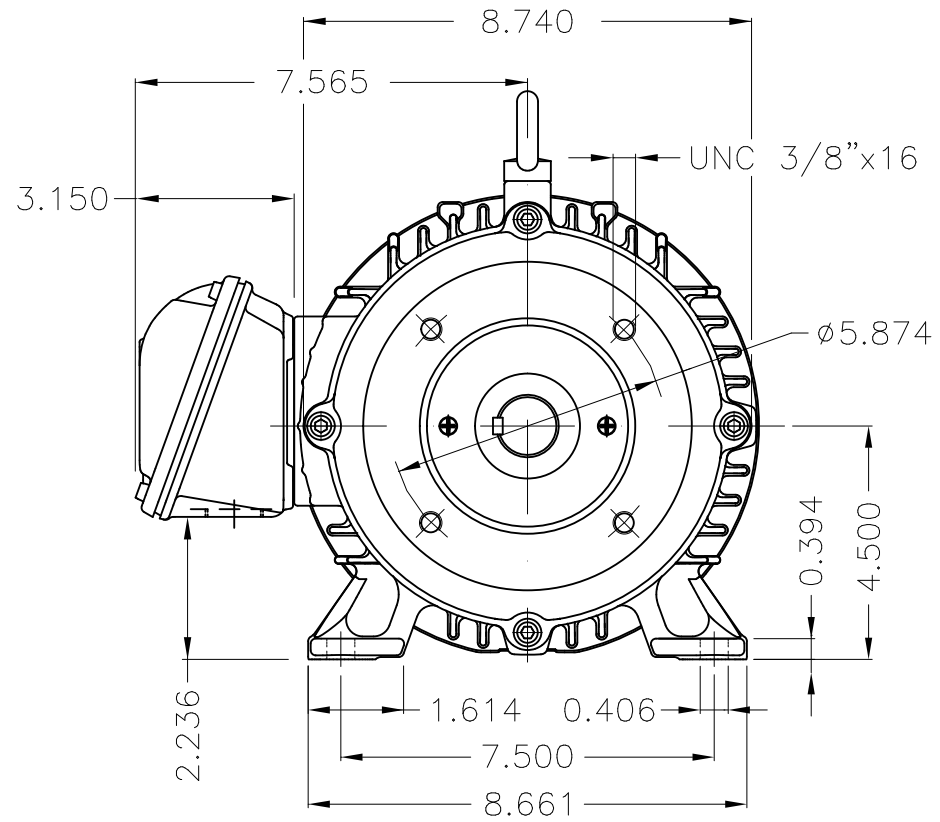

Center hole
EUNC 3/8"-16 WEG TBG253

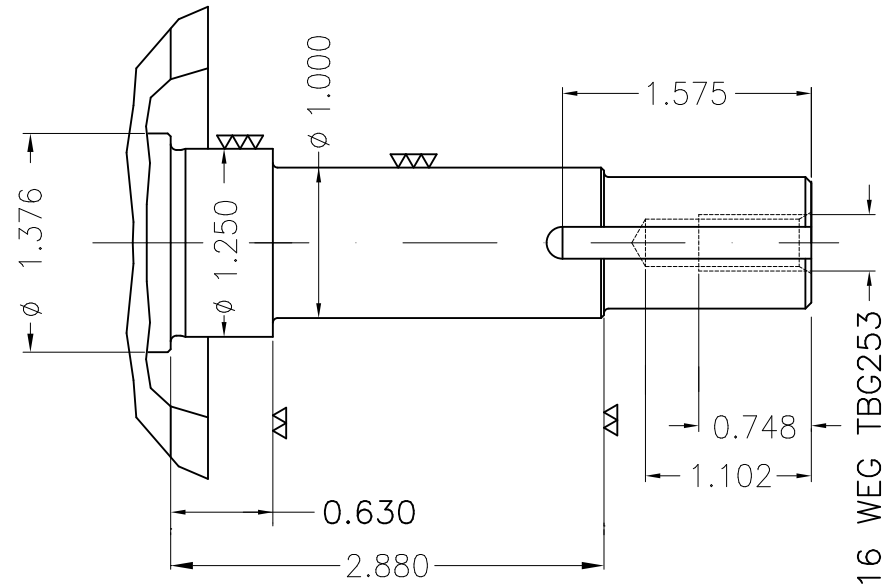

EUNC 3/8"-16 WEG TBG253

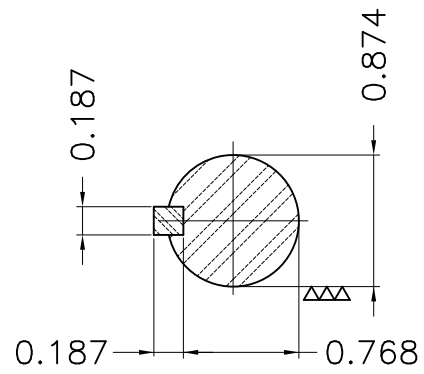

Color RAL 5009
Painting plan 207A
Mounting B34R(D)

ECM	LOC	SUMMARY OF MODIFICATIONS			EXECUTED	CHECKED	RELEASED	DATE	VER
EXECUTED	USERADMIN		THREE PHASE MOTOR W22 NEMA PREMIUM EFF.						
CHECKED			FRAME 182/4JM IP55 TEFC						
RELEASED			WEG code: 11570361						
REL DT	24.07.2017	WMO	Jaragua do Sul	Product Engineering	SHEET	1 / 1			

5 HP 04 Poles 60Hz

A

