

Dimensões em polegada
Dimensions in inches

THIS IS AN UPDATED REVISION, THE
PREVIOUS ONE MUST BE DISREGARDED.

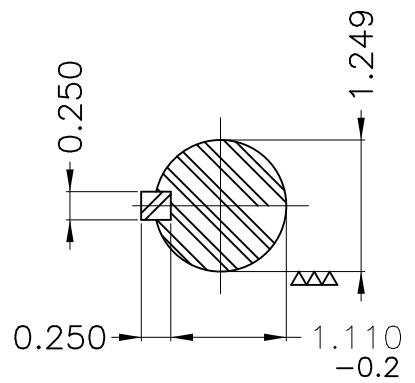

Grounding for leads 5.2–25 mm² / 10–4 AWG

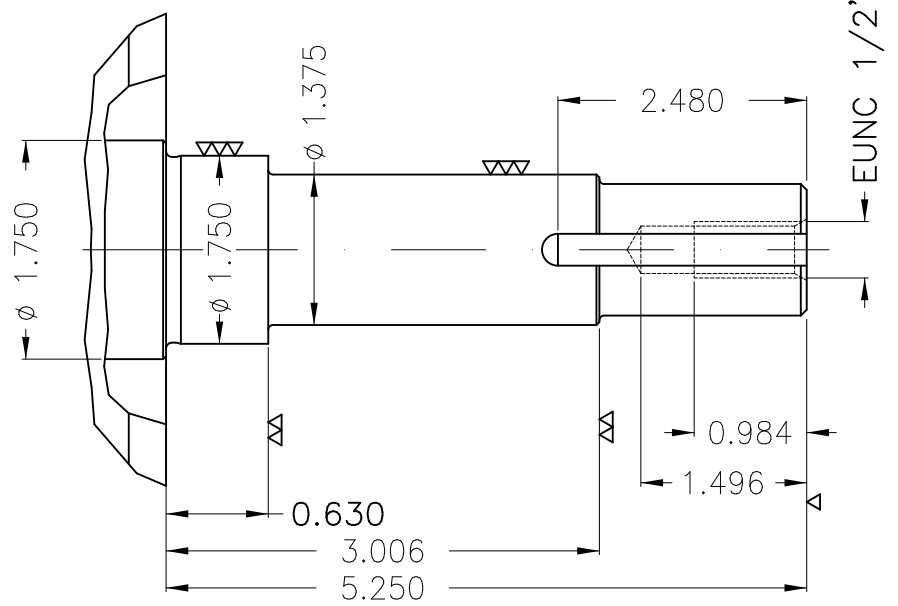
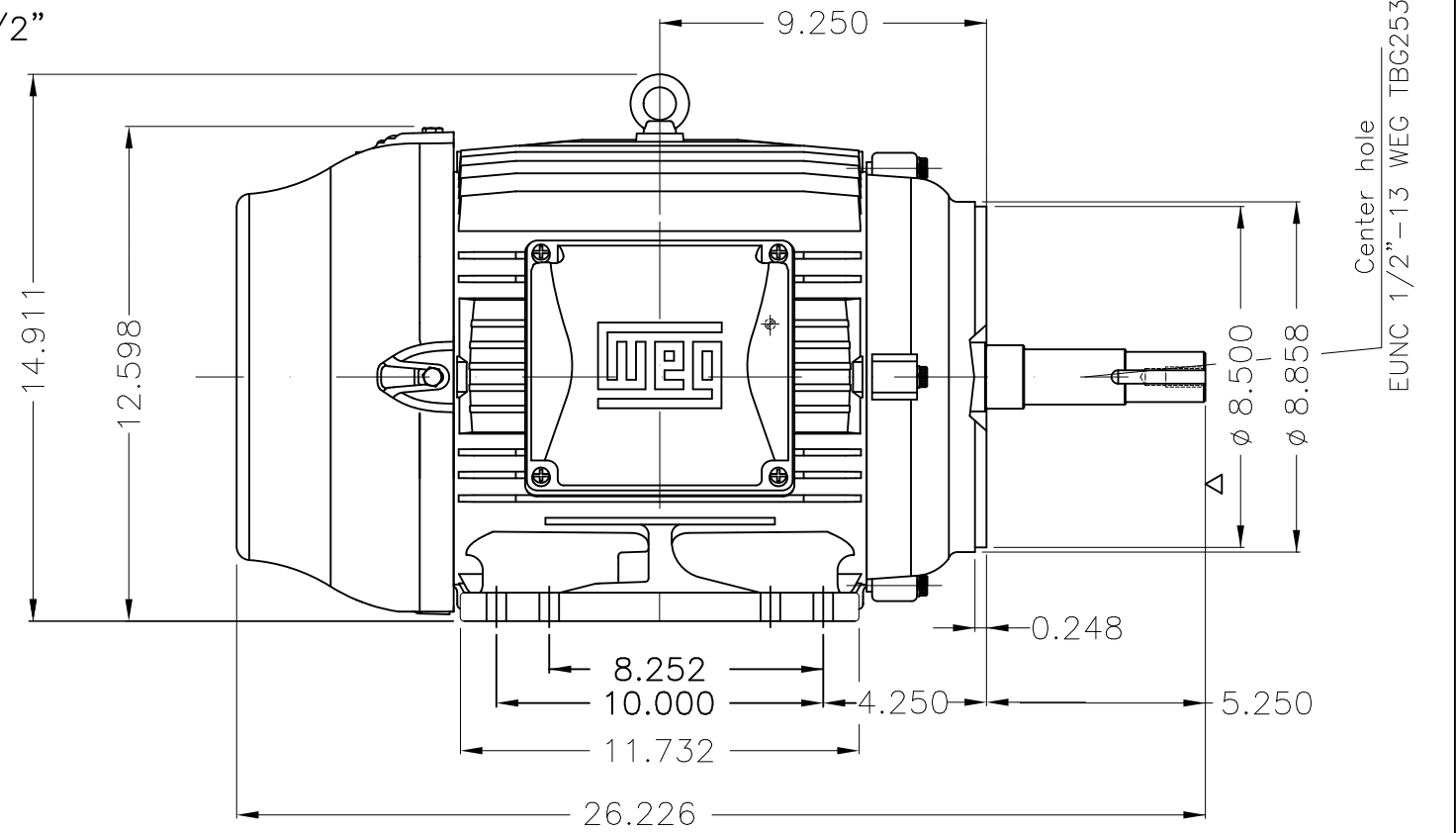
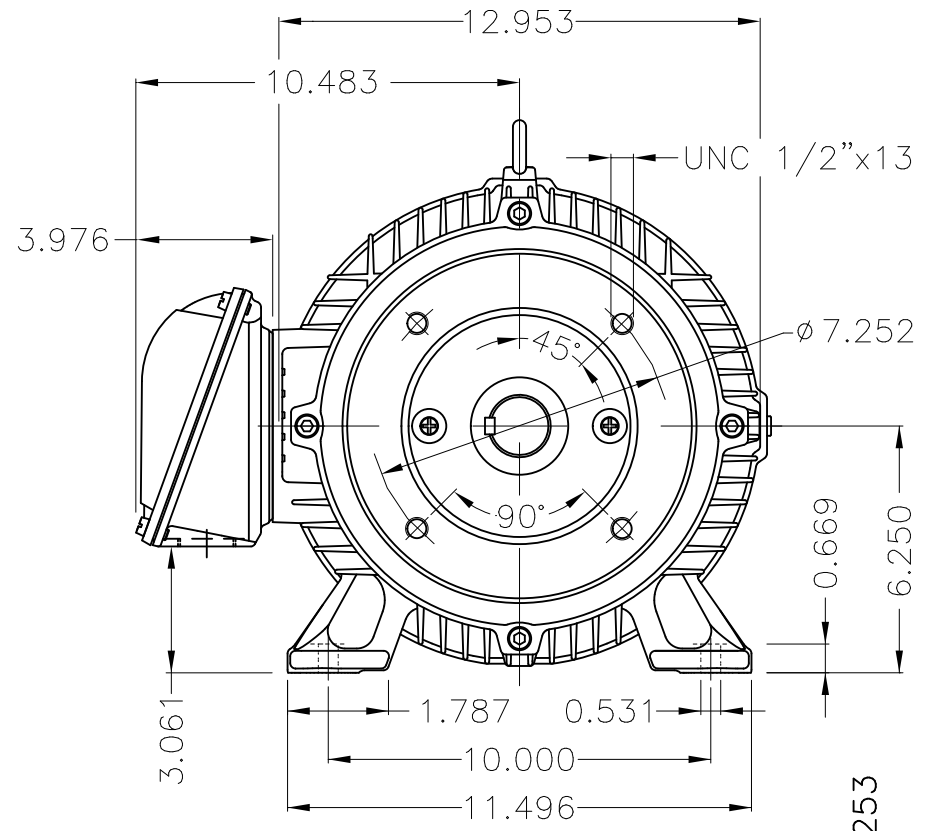

Color RAL 5009
Painting plan 203A
Mounting B34R(D)

ECM	LOC	SUMMARY OF MODIFICATIONS	EXECUTED	CHECKED	RELEASED	DATE	VER
EXECUTED	USERADMIN	THREE PHASE MOTOR W22 NEMA PREMIUM EFF.					
CHECKED		FRAME 254/6JM IP55 TEFC					
RELEASED		WEG code: 12941830					
REL DT	24.07.2017	WMO Jaragua do Sul	Product Engineering	SHEET	1 / 1		

10 HP 06 Poles 60Hz

