

Product Information Packet

January 13, 2017

Data shown is for the current revision model #. Ensure your nameplate model # matches.

Model Number:	5KS511XAA142A
Catalog Number:	Q819
Instruction Manual:	GEI-56128
Connection Diagram:	GEM2034E-FIG20
Outline Drawing:	239C6B00KW

Accessory Connection Diagrams			
Bearing Thermocouple:	None	Heater:	3027JE-1
RTD:	235A3027WN	Thermistor:	None
Thermostat:	None	Winding Thermocouple:	None
Bearing RTD:	235A3027NA		

Table of Contents	
Specification	01
Performance Characteristics	02
Outline Drawing	03
Connection Drawing(s)	04



Marks:

MODEL NUMBER:	5KS511XAA142A	Estimated Weight:	4985 Lbs
Outline Drawing:	239C6B00KW	Time Rating:	CONT
Connection Diagram:	GEM2034E-FIG20	Enclosure:	TEFC
Instruction Book:	GEI-56128	Encl Construction:	841
Design Code:	50BD0174B	Ambient Max(°C):	40
Type:	KS	Alt Ambient Max(°C):	--
Frame:	5011LS	Insulation Class:	F
Phases:	3	NEMA Design:	B
Poles:	2	Nominal Efficiency:	95.8 %
Output Power:	400HP 296KW	Guaranteed Efficiency:	95.0
RPM:	3570	3/4 Load Efficiency:	95.9
Voltage:	575	KVA Code:	G
Hertz:	60	Max KVAR:	50.1
Amps - FL:	334.0	Power Factor:	93.5
Service Factor:	1.15	Bearing - DE:	6315ZC3
Alt Service Factor:	--	Bearing - ODE:	6315ZC3

Enclosure is Totally Enclosed Fan-Cooled

Stamped Nameplate Notes:

EXCEPTION TO IEEE-STD-841-2009: SOUND POWER 94 DBA
TSTAT HTR LDS H 115V 200W
DE BRG 75BC03XP3, ODE BRG 75BC03XP3
ROT CW FACING ODE LEAD/PH SEQUENCE 1-2-3/1-2-3
INVERTER DUTY PER NEMA MG1 PART 31
ALTERNATE RATING FOR PWM CONTROL:1.0SF 40C AMBIENT
VAR TORQUE RANGE 0-60 HZ
MAXIMUM EXPOSED INTERNAL AND EXTERNAL SURFACE
TEMPERATURES DO NOT EXCEED 200C UNDER USUAL
SERVICE CONDITIONS AT 1.0SF
MAXIMUM SPACE HEATER SURFACE TEMPERATURE FOR
NORMAL OPERATION AT RATED CONDITIONS 160C
STAMP NP249A5499AP AS BELOW:
MODEL:5KS511XAA142A S/N: XXX
EX NA IIC T3 GC CSA.09.2216219
CLASS I, ZONE 2, AEX NA IIC T3
CLASS I, DIV 2, GROUPS A, B, C, D T3
-25C <= TAMB <= 40C
FOR DIRECT COUPLED LOAD ONLY

Additional Information:

2P - LS EXTN - SPLIT LEAD
PAINTED FRAME ID & SHAFT, FAN COVER INSIDE &
ODE E/S OUTSIDE
CW ROTATION FACING OPPOSITE DRIVE END
1260 CU IN - 2(4.00" NPT) - 4 DRAIN HOLES
C/B GRD PLATE

INPRO SEAL BOTH ENDS
OIL RESISTANT SLEEVING ON LEADS
.0015" TIR SHAFT RUNOUT
ROUTINE TEST REPORT AND 5 POINT VIBRATION TEST
REPORT INCLUDED IN C/B
COPPER WASHER UNDER HEADS OF BEARING CAP BOLTS,
APPLY TITE-SEAL (A50CD427A) ON BEARING CAP SCREWS,
RABBETS AND PLUG THREADS.
100 OHM WINDING RTD LEADS TO AUX C/BOX OPP MAIN C/BOX
SUGGESTED WINDING RTD SETTINGS
ALARM 165C TRIP 175C
115V TSTAT CTRLD HTR LDS TO AUX BOX OPP MAIN CONDUIT BOX
SPACE HEATER CAUTION NAMEPLATE
BEARING RTD 100 OHM ON BOTH ENDS
SUGGESTED BEARING RTD SETTINGS
ALARM 115C TRIP 125C
NEMA TYPE GRD PAD
F1 MOUNTING

Performance Characteristics

1st Winding 1st Connection

Design: 50BD0174B

Marks:

LOAD %	125.0	115.0	100.0	75.0	50.0	25.0	0.0
% EFF	95.42	95.6	96	95.94	95.56	93.26	0.00
% PF	93.32	93.55	93.72	93.29	90.83	79.67	8.18
AMPS	420.42	385.12	332.39	250.97	172.53	100.77	55.74

TORQ(FL)#FT	588.18	TORQ(LR)%FL	84.32	TORQ(BD)%FL	281.21
AMPS(LR)	2152.69	PF AT START	0.14		

This motor is capable of two cold or one hot start with a maximum connected load inertia of 997 Lb-Ft Sq (41.97 Kg-meter Sq)at 100% voltage, where the load torque varies with the square of the speed. Acceleration time with maximum inertia and the above load type is 34 seconds. Safe stall time at 100% voltage is 63 seconds cold, 40 seconds hot. Rotor inertia is 89.68 Lb-Ft Sq (3.78 Kg-meter Sq).

Open Circuit A-C:	1.952	Short Circuit D-C:	0.047
Short Circuit A-C:	0.054	X/R Ratio:	17.773
Stator Slots:	48	Rotor Slots:	40

Speed Torque Current Curve (First Connection, First Speed)

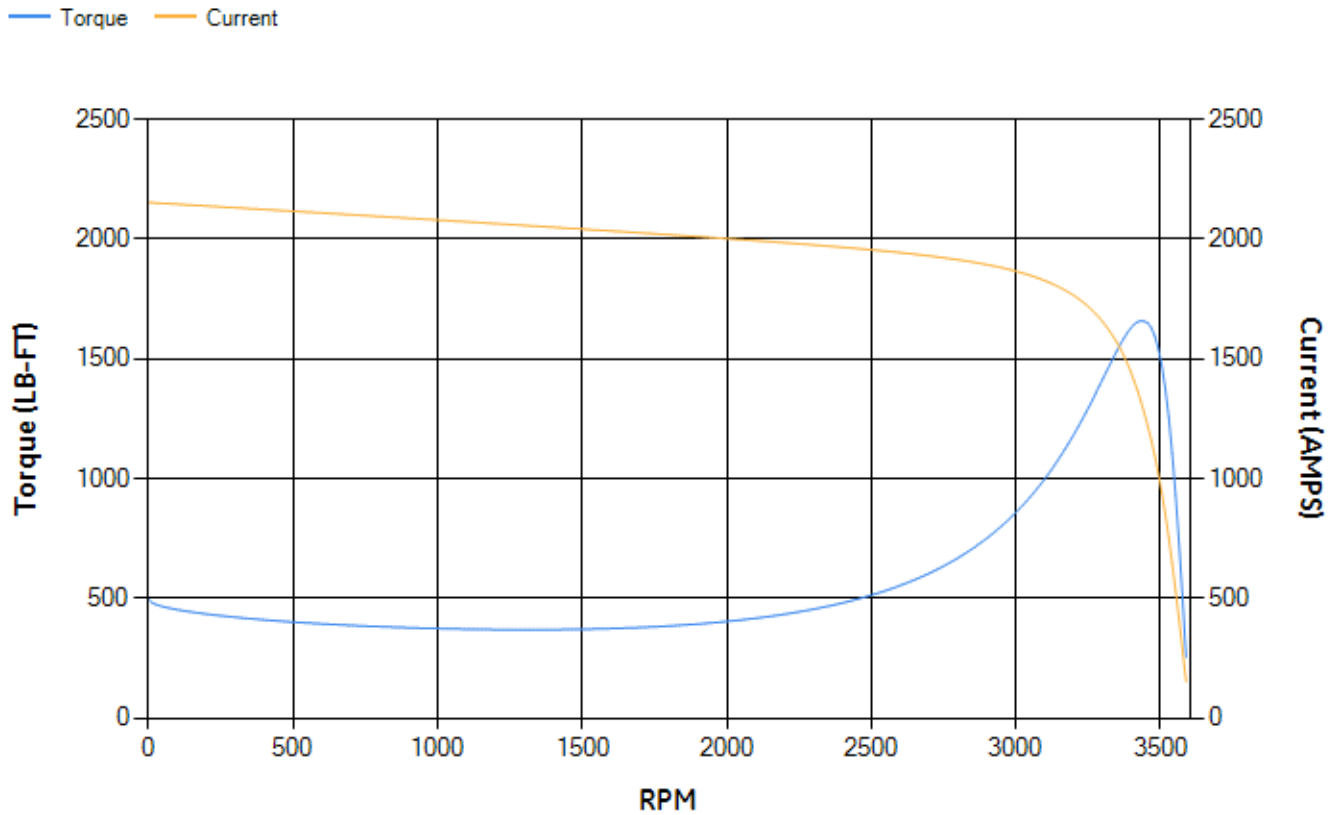

Marks:

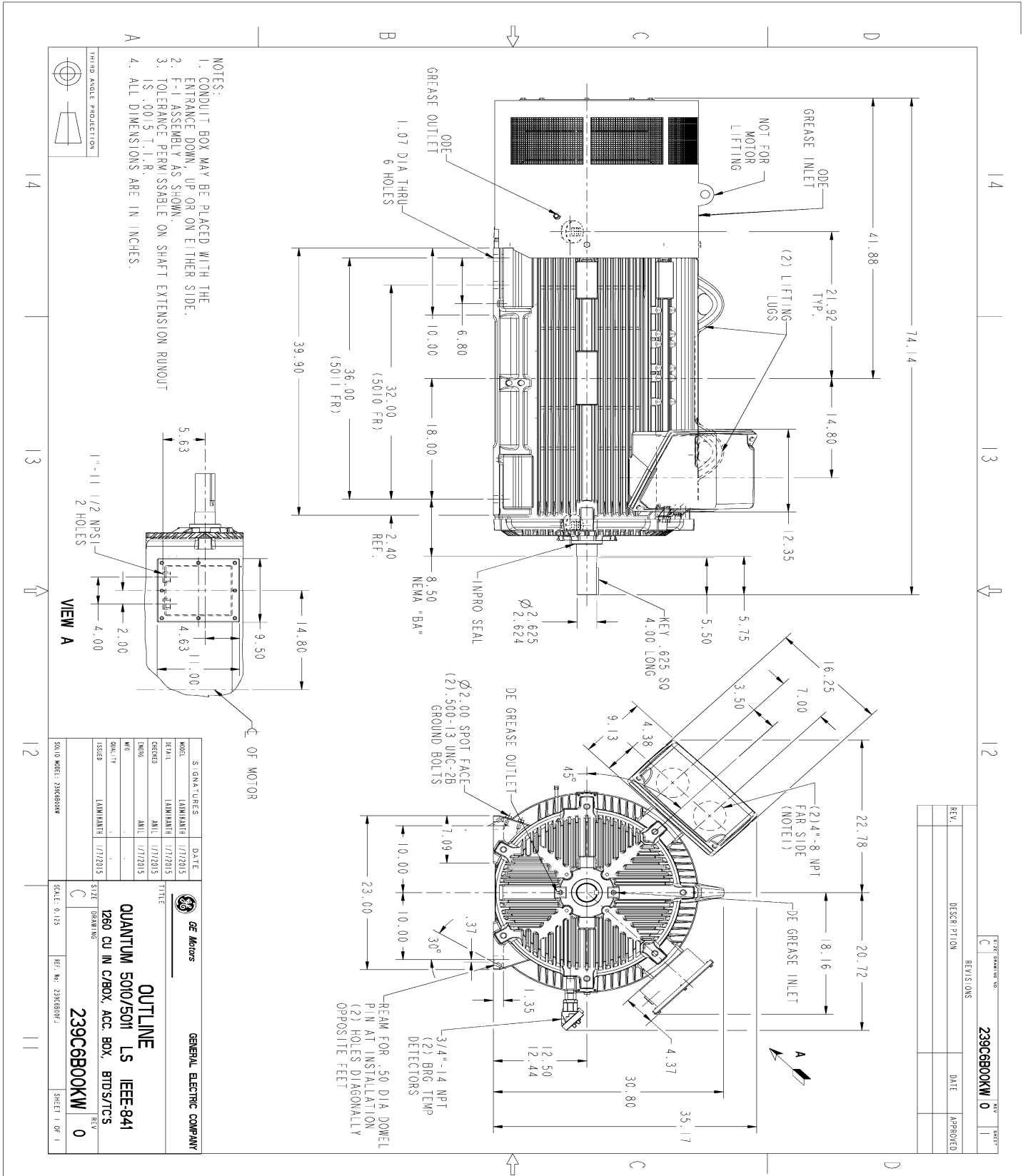

REV.	DESCRIPTION	DATE	APPROVED

239C6B00KW 0

Marks:

Connection Diagram
GEM2034E-FIG20

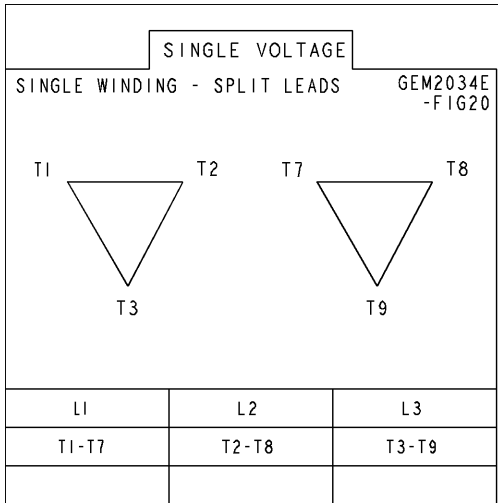

Heater Connection
3027JE-1

FIG. 1
HEATER CONN.

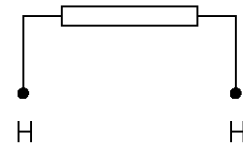

CONTROL	L1	L2
VOLTAGE ONLY	H	H

SHEET

REV

235A3027WN

SIZE DRAWING NO. A

GE PROPRIETARY INFORMATION

This document is the property of General Electric Company ("GE") and contains proprietary information of GE. This document is loaned on the express condition that neither it nor the information contained therein shall be disclosed to others without the express written consent of GE Industrial Systems, and that the information shall be used by the recipient only as approved expressly by GE Industrial Systems. This document shall be returned to GE upon its request. This document may be subject to certain restrictions under U.S. export control laws and regulations.

REVISIONS

REV.	DESCRIPTION	DATE	APPROVED

THIRD ANGLE PROJECTION

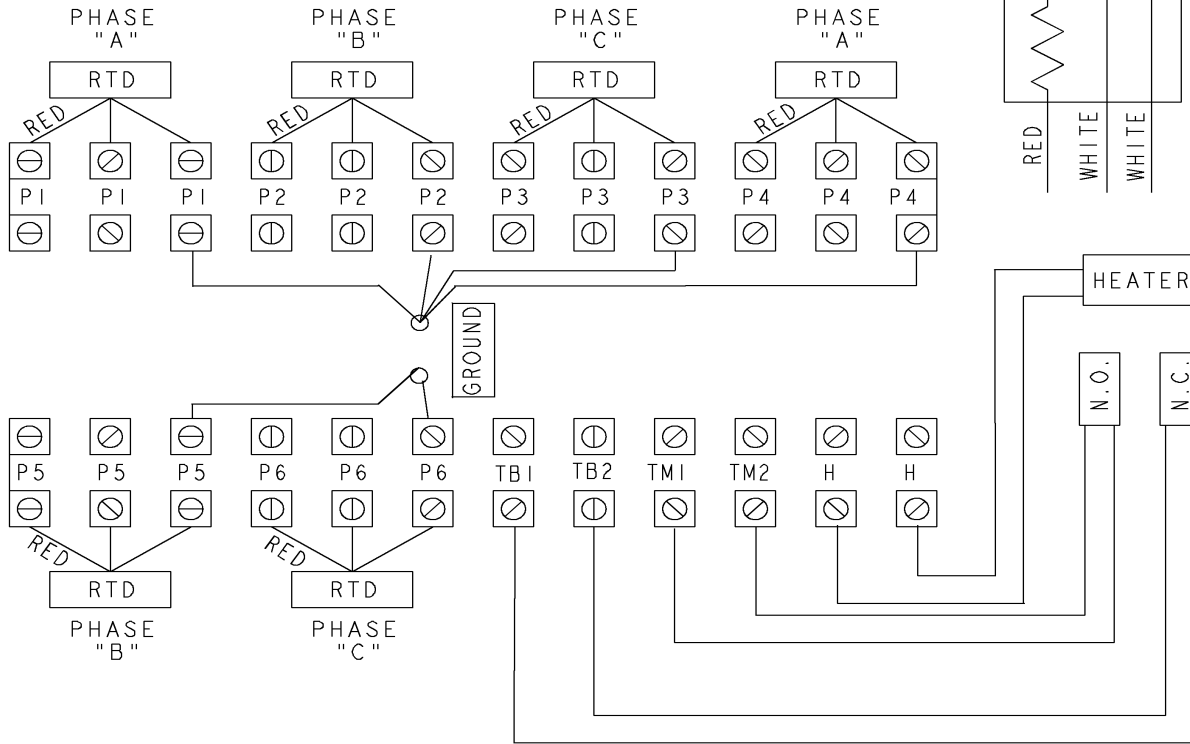
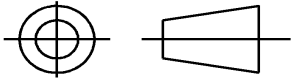

- NOTE 1: TERMINAL LABELS ARE PROVIDED FOR ACCESSORIES THAT MAY OR MAY NOT BE INCLUDED WITH THE MOTOR.
- NOTE 2: SPARE RTDS (P7 & P8) FURNISHED IN CASE OF FAILURE IN OTHER RTDS (P1-P6). PHASE LOCATION WILL DEPEND UPON NUMBER OF POLES WINDING CONFIGURATION.
- NOTE 3: IT IS RECOMMENDED THAT RTDS BE GROUNDED AT EITHER THE MACHINE OR CONNECTED TO A GROUNDED CONTROL CIRCUIT. FOR PROPER OPERATION DO NOT GROUND AT THE MACHINE IF CONNECTED TO A GROUND CIRCUIT AT THE CONTROL.

Part must conform to SI 900000 Sect. 4, Toxicity Procedure

FOR ADDITIONAL INFO REFER TO:	SIGNATURES	DATE
APPLIED PRACTICES	MODEL	
DIMENSIONS ARE IN INCHES	DETAIL VIVEK	07/19/13
TOLERANCE ON:	CHECKED VIJAY	07/19/13
1 PL DECIMALS ± 0.1	ENGRG	
2 PL DECIMALS ± 0.02	MFG	
3 PL DECIMALS ± 0.005	QUALITY	
ANGLES ± 0.5	ISSUED VIVEK	07/19/13
FRACTIONS ±		
FINISH ✓		
MATERIAL	SOLID MODEL: MODEL NAME	

GE Motors GENERAL ELECTRIC COMPANY

TITLE
CONNECTION DIAGRAM
WINDING RTD'S & T'STATS & HEATERS

SIZE DRAWING: A 235A3027WN REV 0

SCALE: NA SHEET 1 of 1



REV SH 1 1	THIRD ANGLE PROJECTION	REVISIONS			
		REV	DESCRIPTION	DATE	APPROVED
		1	ISAAC #12-1124	HARI	11/19/12

SIZE A
 DWG NO 235A3027NA

CONFIDENTIAL AND PROPRIETARY
 This document is the property of General Electric Company and contains proprietary and confidential information of the Motor Business Group (MBG). The document is loaned on the express conditions that neither it nor the information contained therein shall be disclosed to others without the express consent of MBG and that the information shall be used by the recipient only as approved expressly by MBG. Also, the document shall be returned to MBG upon its request.

BEARING RTDS

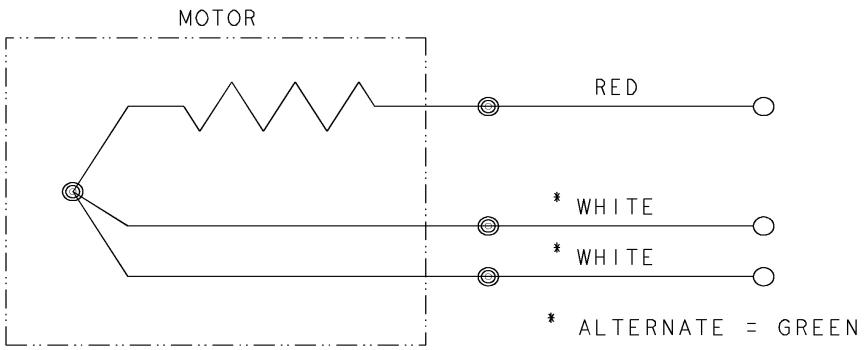

UNLESS OTHERWISE SPECIFIED	SIGNATURES	DATE
DIMENSIONS ARE IN INCHES	DRAWN D.E. BAIR	12/16/92
TOLERANCES ON:	CHECKED D.E. BAIR	12/16/92
2 PL DECIMALS ±	ENGRG K. DESAI	12/16/92
3 PL DECIMALS ±	ISSUED D.E. BAIR	12/16/92
ANGLES ±		
FRACTIONS ±		
MATERIAL:		
APPLIED PRACTICES:	CAD NO. F500:235A3027NA	

GE Motors

Fort Wayne, Indiana

CONNECTION DIAGRAM

BEARING RTDS

SIZE A	FSCM NO	DWG NO 235A3027NA
SCALE 1/1	SHEET 1 OF 1	

DISTR TO