

DATE  
JAN 19, 2012

CATALOG NO.  
GHV0/32C

OUTLINE DIMENSIONS  
3-PHASE INDUCTION MOTOR

MODEL TYPE:  
AETHCF

FRAME NO. 56C

Pole	HP	KW	Hz	VOLT	Syn. Speed R. P. M
2	1/3	.22	60	230/460	3600

Ins.	Rating	Dimensions in	Approx Weight	Bearings
F	CONT.	inch	24 lbs.	DF: 6204ZZ NDE: 6203ZZ

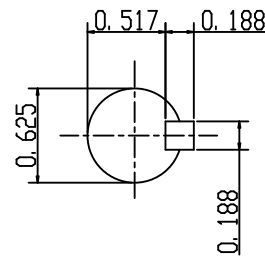
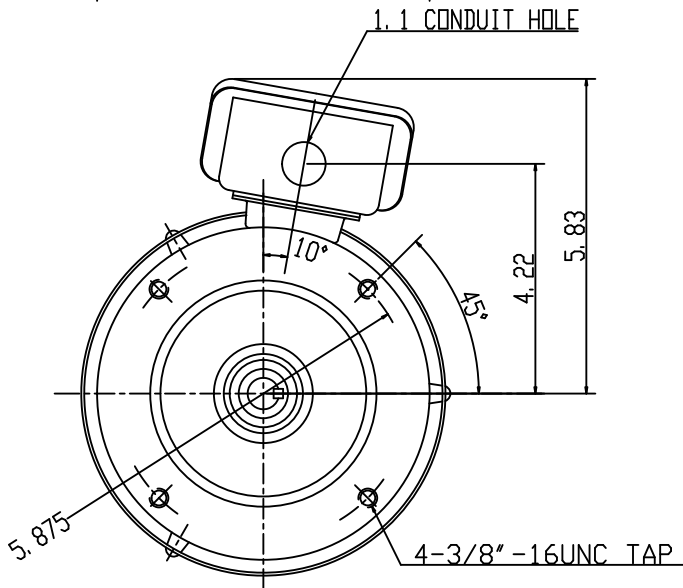
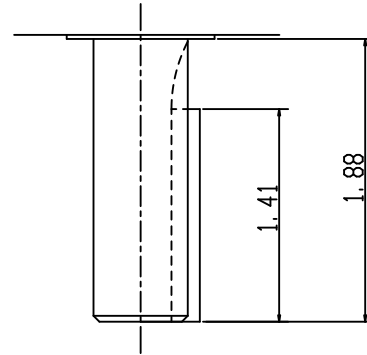
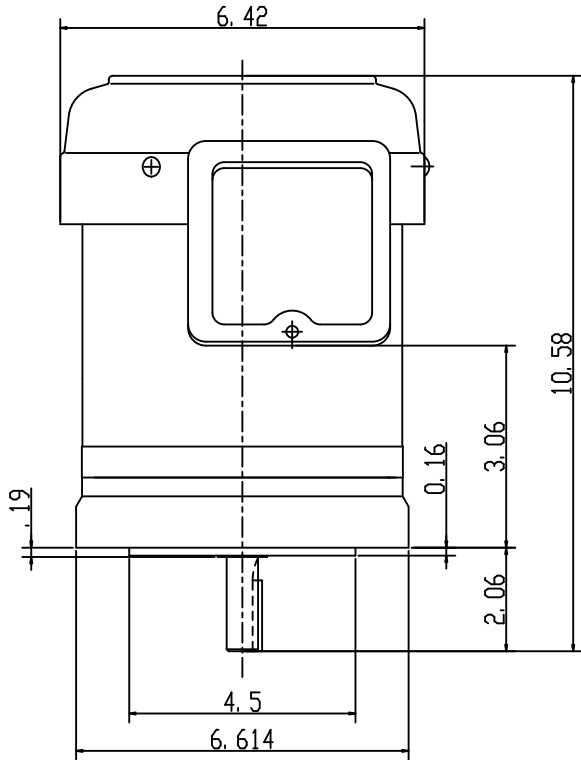

APPD.	W. H. TSAI	03 31 03
CHKD.	J. B. CHEN	03 31 03
DWN.	P. J. CHEN	03 31 03

TECO Westinghouse

DWG NO.  
31049Z105  
0724