

Dimensões em polegada
Dimensions in inches

THIS IS AN UPDATED REVISION, THE
PREVIOUS ONE MUST BE DISREGARDED.

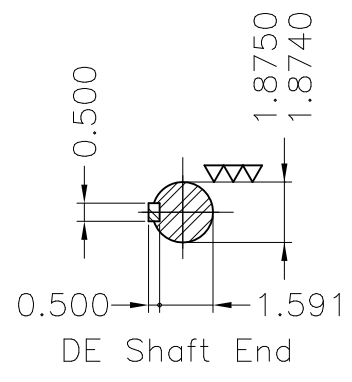
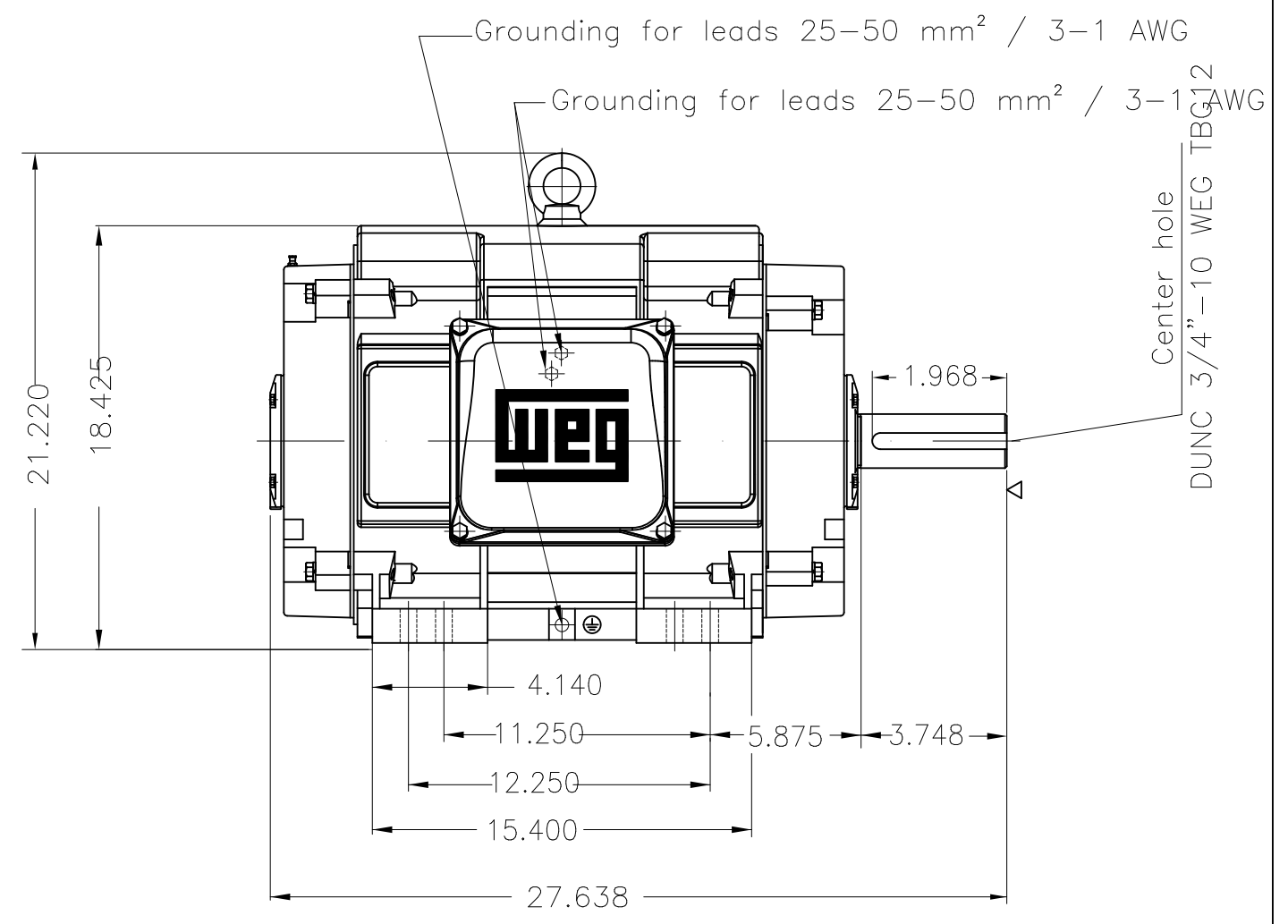
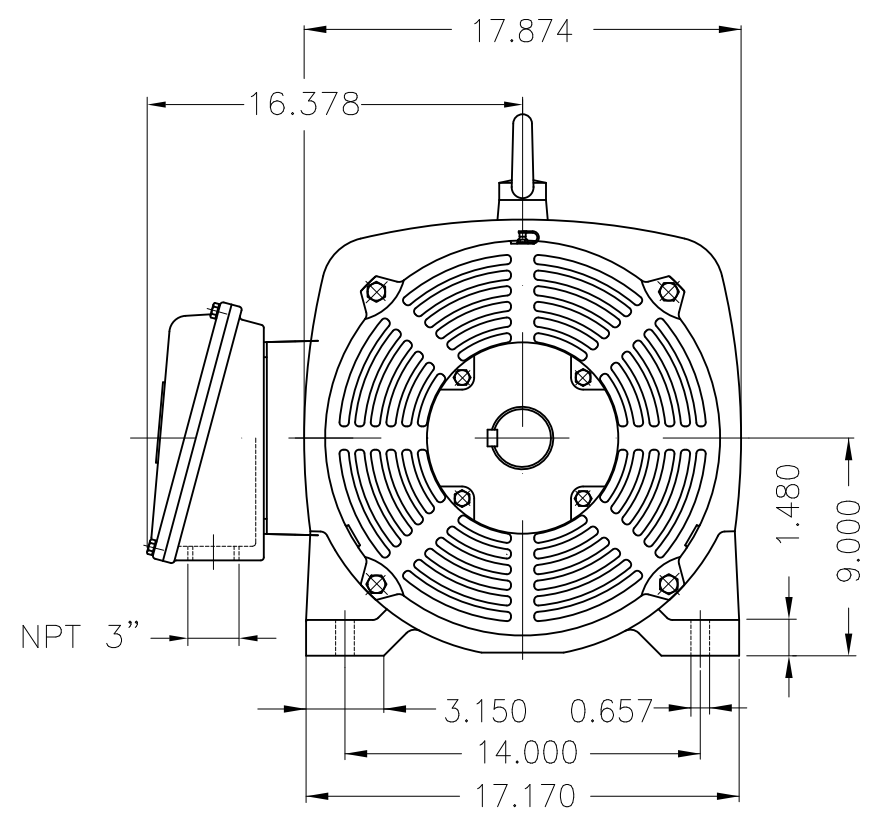

Certification UL/FIRE PUMP
TS shaft end
Color RAL 3002
Painting plan 203A
Mounting B3R(D)

ECM	LOC	SUMMARY OF MODIFICATIONS	EXECUTED	CHECKED	RELEASED	DATE	VER
EXECUTED	USERADMIN	THREE PHASE MOTOR - HIGH EFFICIENCY					
CHECKED		FRAME 364/5TS IP23 ODP					
RELEASED		WEG code: 11675807					
REL DT	24.07.2017	WMO Jaragua do Sul	Product Engineering	SHEET	1 / 1		

75 HP 04 Poles 60Hz

A

