

Dimensões em polegada  
Dimensions in inches

THIS IS AN UPDATED REVISION, THE  
PREVIOUS ONE MUST BE DISREGARDED.

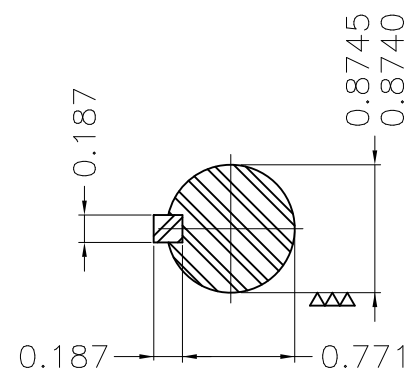
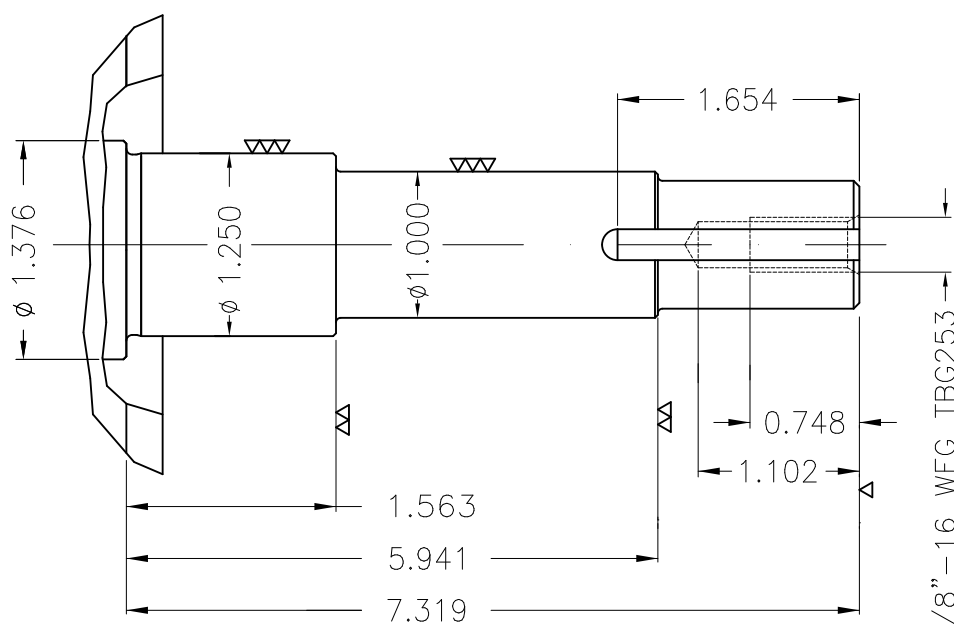
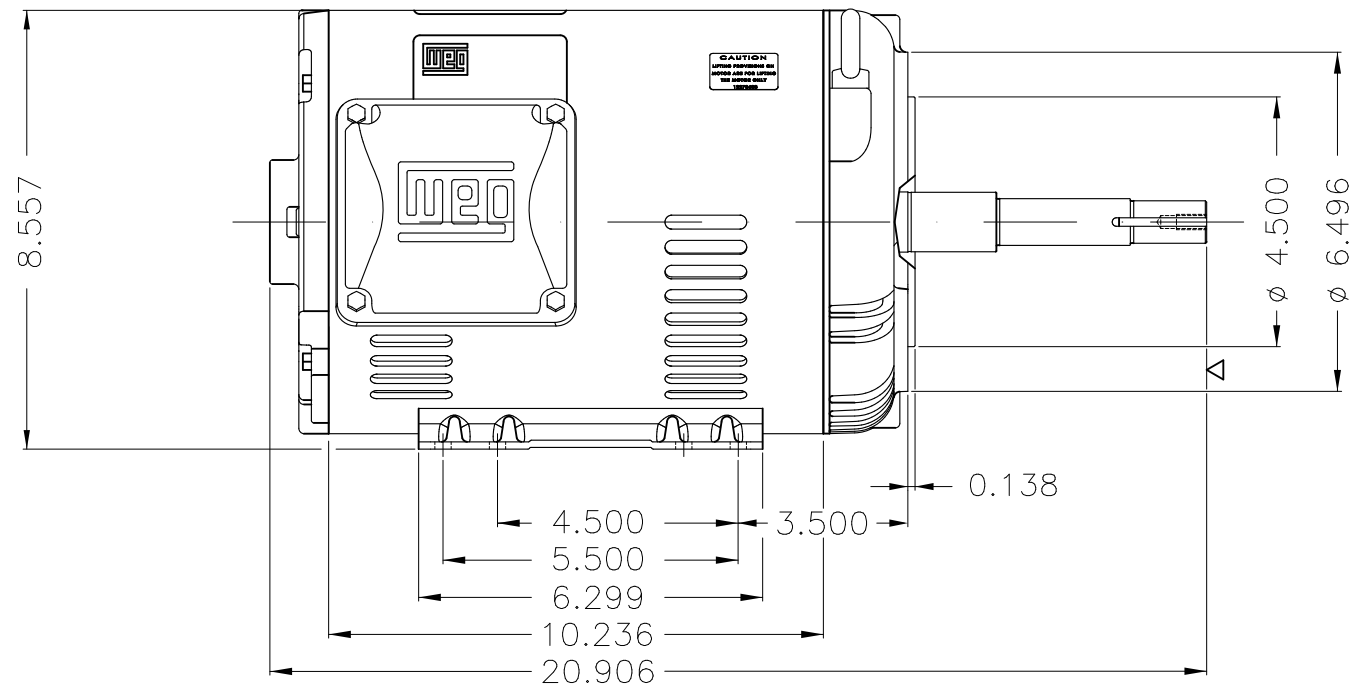
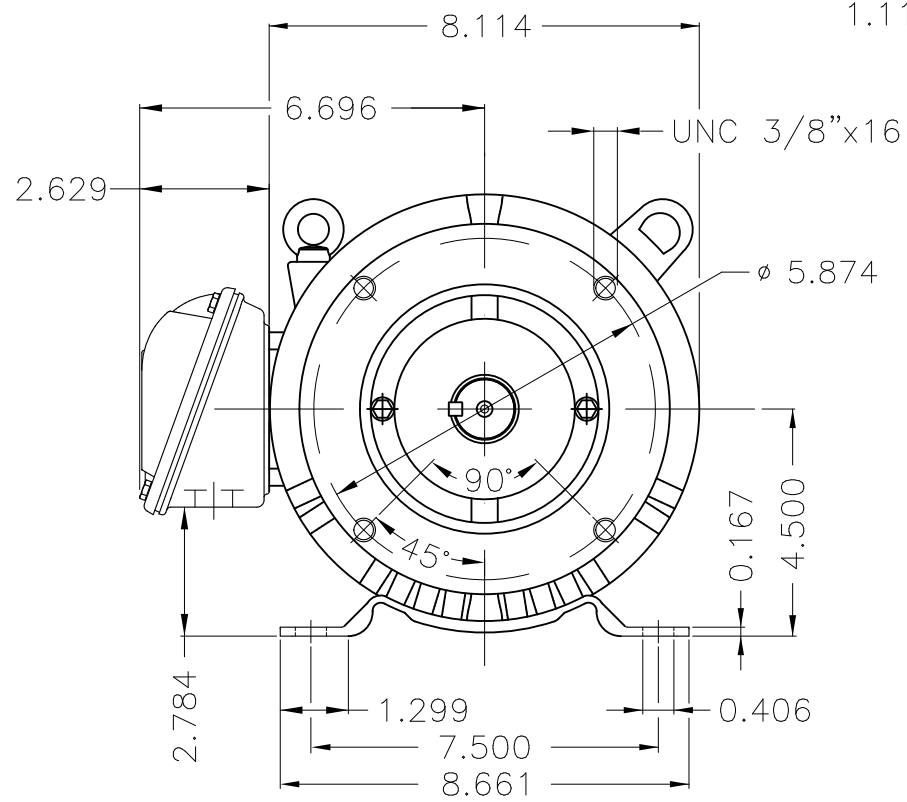
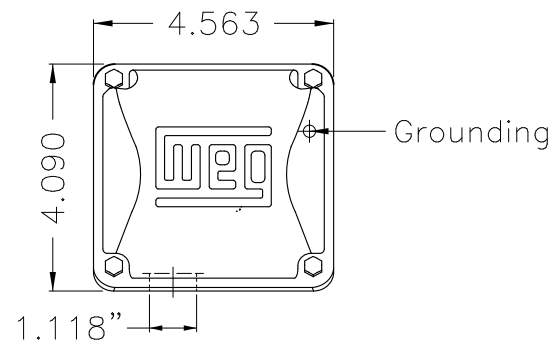

EUNC 3/8"-16 WEG TBG253

Color Munsell N 1 matte black  
Painting plan 207N  
Mounting F-1/B34R(D)

ECM	LOC	SUMMARY OF MODIFICATIONS	EXECUTED	CHECKED	RELEASED	DATE	VER
EXECUTED	USERADMIN	THREE PHASE ODP ROLLED STEEL NEMA PREM.					
CHECKED		FRAME 182/4JP ODP					
RELEASED		WEG code: 12682724					
REL DT	24.07.2017	WMO Jaragua do Sul	Product Engineering	SHEET	1 / 1		

5 HP 04 Poles 60Hz

A

