

Dimensões em mm  
Dimensions in mm

THIS IS AN UPDATED REVISION, THE PREVIOUS ONE MUST BE DISREGARDED.

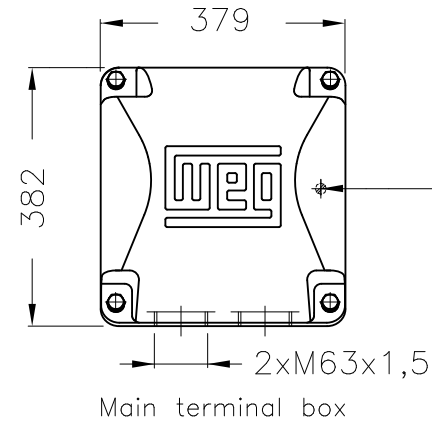

Grounding for leads 35–70 mm<sup>2</sup> / 1–2/0 AWG

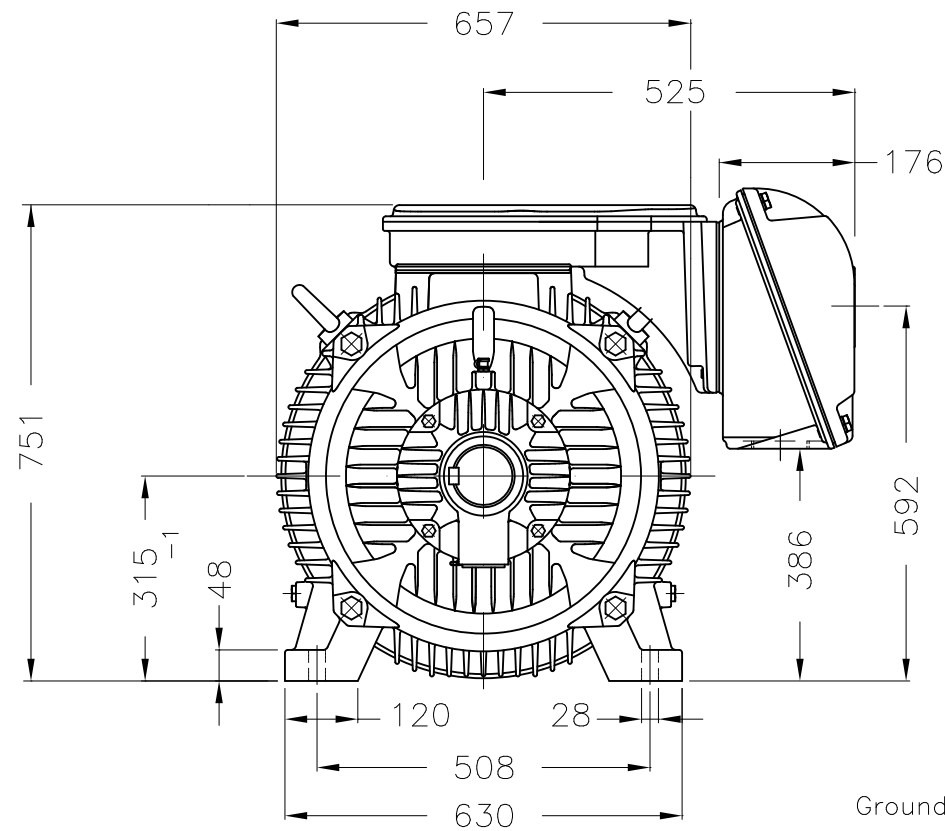
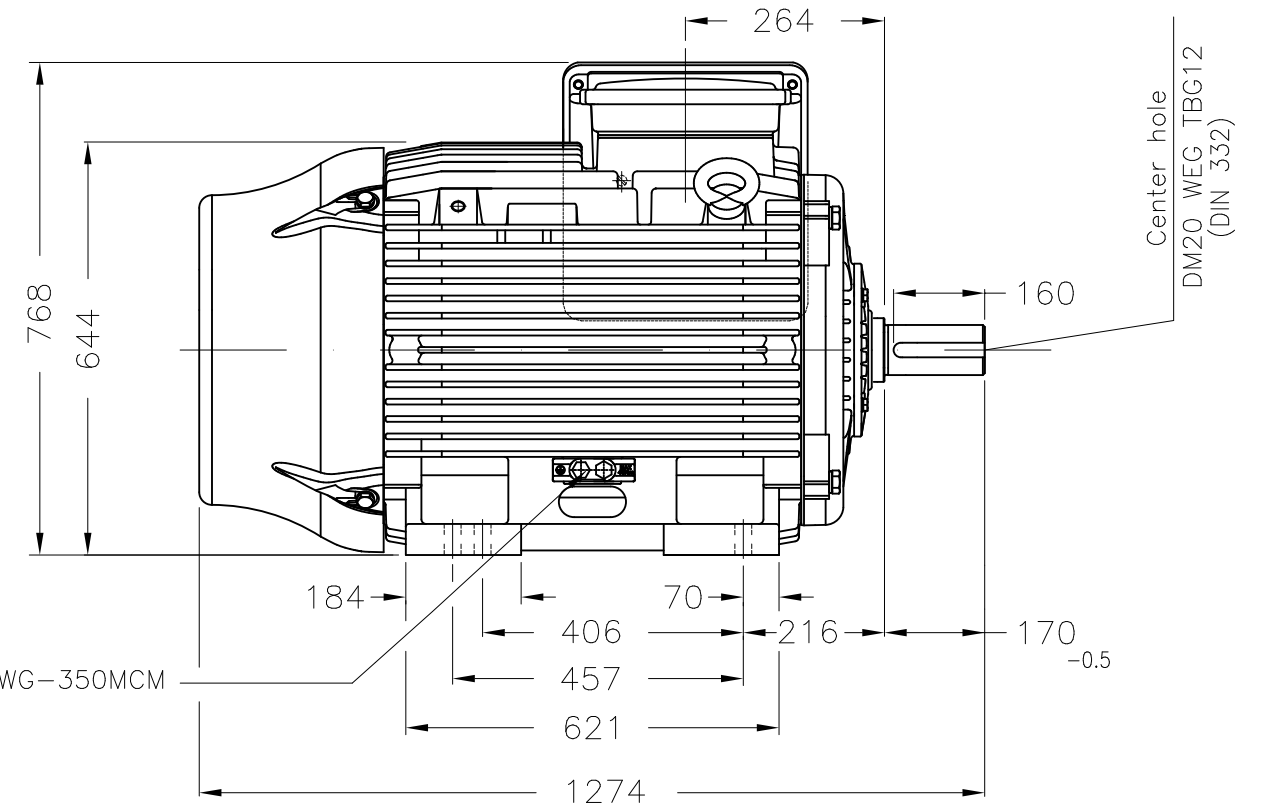

Grounding for leads 25–185 mm<sup>2</sup> / 3AWG–350MCM

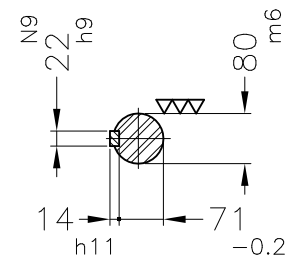

DE Shaft End

NDE endshield with electrically insulated bearing hub  
Color RAL 5009  
Painting plan 203A  
Mounting B3L(E)

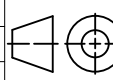
ECM	LOC	SUMMARY OF MODIFICATIONS			EXECUTED	CHECKED	RELEASED	DATE	VER
EXECUTED	USERADMIN	 THREE PHASE W22 TRU-METRIC PREMIUM EFF FRAME 315S/M IP55 TEFC WEG code: 12111792							
CHECKED									
RELEASED									
REL DT	24.07.2017	WMO	Jaragua do Sul	Product Engineering	SHEET	1 / 1			

125 HP 06 Poles 60Hz

A

