

DATE
APRIL 30, 2004
CATALOG NO.
XV0026C

OUTLINE DIMENSIONS
3-PHASE INDUCTION MOTOR

MOTOR TYPE:
AEUHXF
FRAME NO. 184TC

Pole	HP	KW	Hz	VOLT	Syn. Speed RPM
6	2	1.5	60	230/460	1200

Ins	Rating	Dimension in	Approx Weight	Bearings
F	CONT.	inches	150 lbs.	DE: 6306ZZ NDE: 6306ZZ

Totally Enclosed Fan-Cooled Type, Squirrel-Cage Rotor.

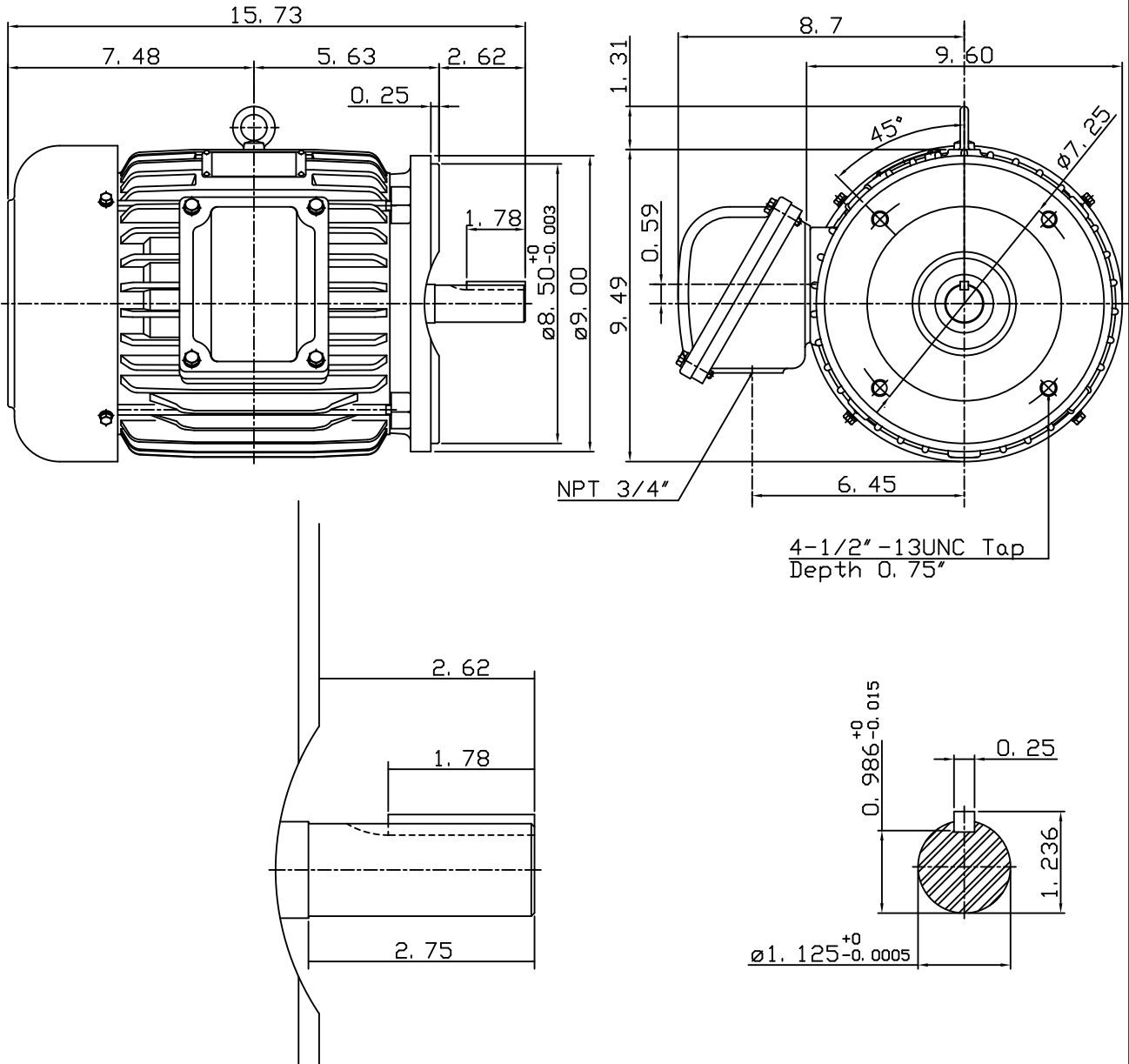

NOTE:
1. EXPLOSION PROOF:
CLASS I GROUP D AND
CLASS II GROUP E, F, G.

DWN.	J. H. LIANG	11-12-98
CHKD.	C. S. LO	11-23-98
APPD.	Y. B. HUANG	11-23-98

TECO Westinghouse

DWG NO.
31049U552000